

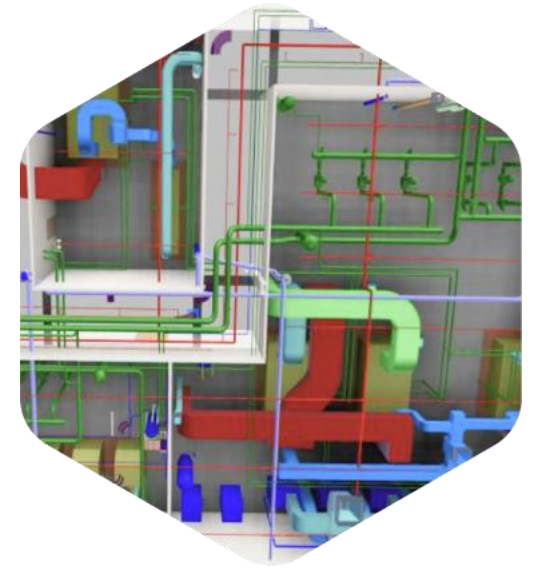

# COMPANY OVERVIEW

Advenser is a multi-disciplined engineering company delivering advanced engineering services & solutions to the construction industry through innovative practices, utilizing BIM and advanced technological tools. Since 2007, we have accumulated extensive experience in the AEC industry, delivering a variety of complex projects across multiple countries with a proven track record of success.

Our engineering team, with a workforce of more than 300+ Engineers with Architectural, Structural and MEP experience, have the expertise and skillsets to meet the demands of any complex project anywhere in the world. We streamline our services to match & adapt to your constantly evolving needs.



# OUR CLIENT BASE

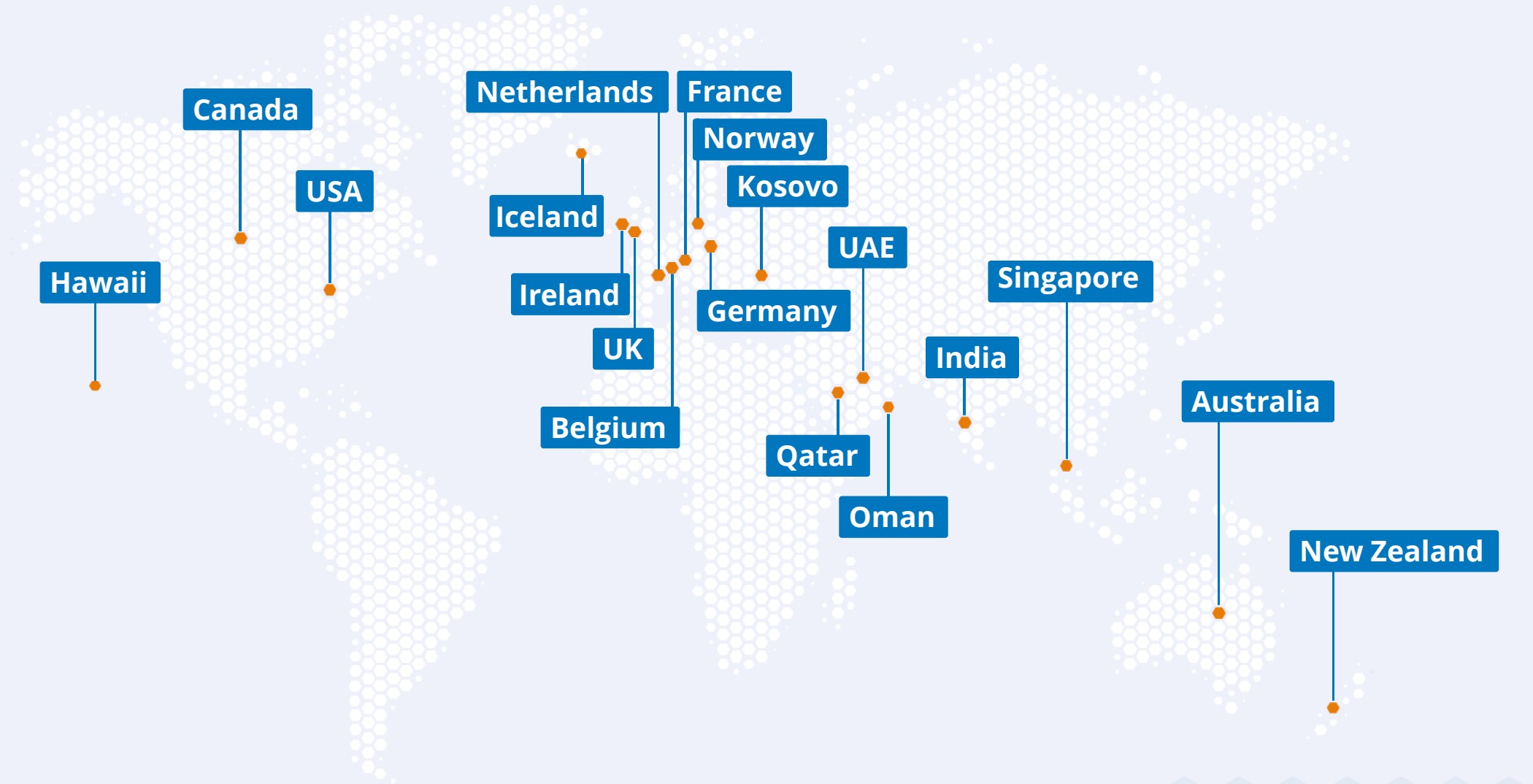

# WHAT MAKES US UNIQUE

Development, management & streamlining of integrated multi-disciplinary performance models of projects & products



## Quality Standards

Multi-stage quality control methods ensure exceptional engineering quality



## Global Operations

Sales offices & operation in multiple countries



## Comprehensive Solutions

Comprehensive BIM / CAD Services for Architectural, Engineering, Construction & Manufacturing Industry under one roof



## End to End Service

Services that span the complete project life cycle from design to maintenance



## Global Project Experience

Global track record across North America, Europe, Australasia & Middle East



## Trade Knowledge & Expertise

Expert resources with multinational project experience & trade knowledge



# WHERE ARE WE NOW

Clients spanning across 18 countries with projects experience in over 4 continents

Multi-disciplinary engineering departments for Architecture, Mechanical, MEP, Façade, Precast, Steel & Rebar

Exceptional team of over 300+ engineers with a diverse array of perspectives, talents, business experience and technical expertise

An umbrella of diverse services and solutions for all stages of a project from design through construction to facility management

Diverse experience portfolio in residential, commercial, industrial, healthcare and educational projects

Around 10,000 projects from over 1000 clients



From humble beginnings, we have now grown to be one of most prominent global engineering services providers by setting the highest for our conduct and reputation in everything we do.

# OUR SERVICES

ARCHITECTURAL BIM



BIM OBJECT LIBRARIES

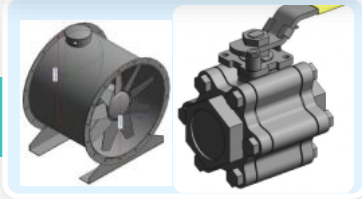

COMPREHENSIVE BIM



FAÇADE DETAILING

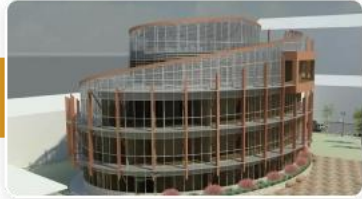

INFRASTRUCTURE BIM



INDUSTRIAL PLANT DIGITIZATION



MECHANICAL CAD/CAM



MEP COORDINATION

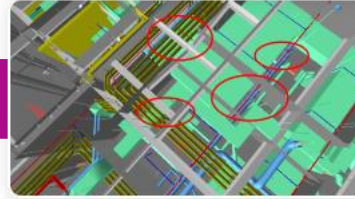

SCAN TO BIM



STEEL/PRECAST/REBAR DETAILING

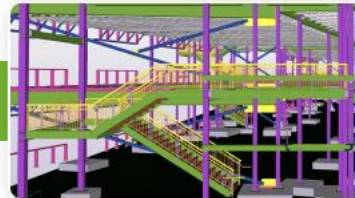

BIM TRAINING



# ADVENSER IN BIM SUPPLY CHAIN

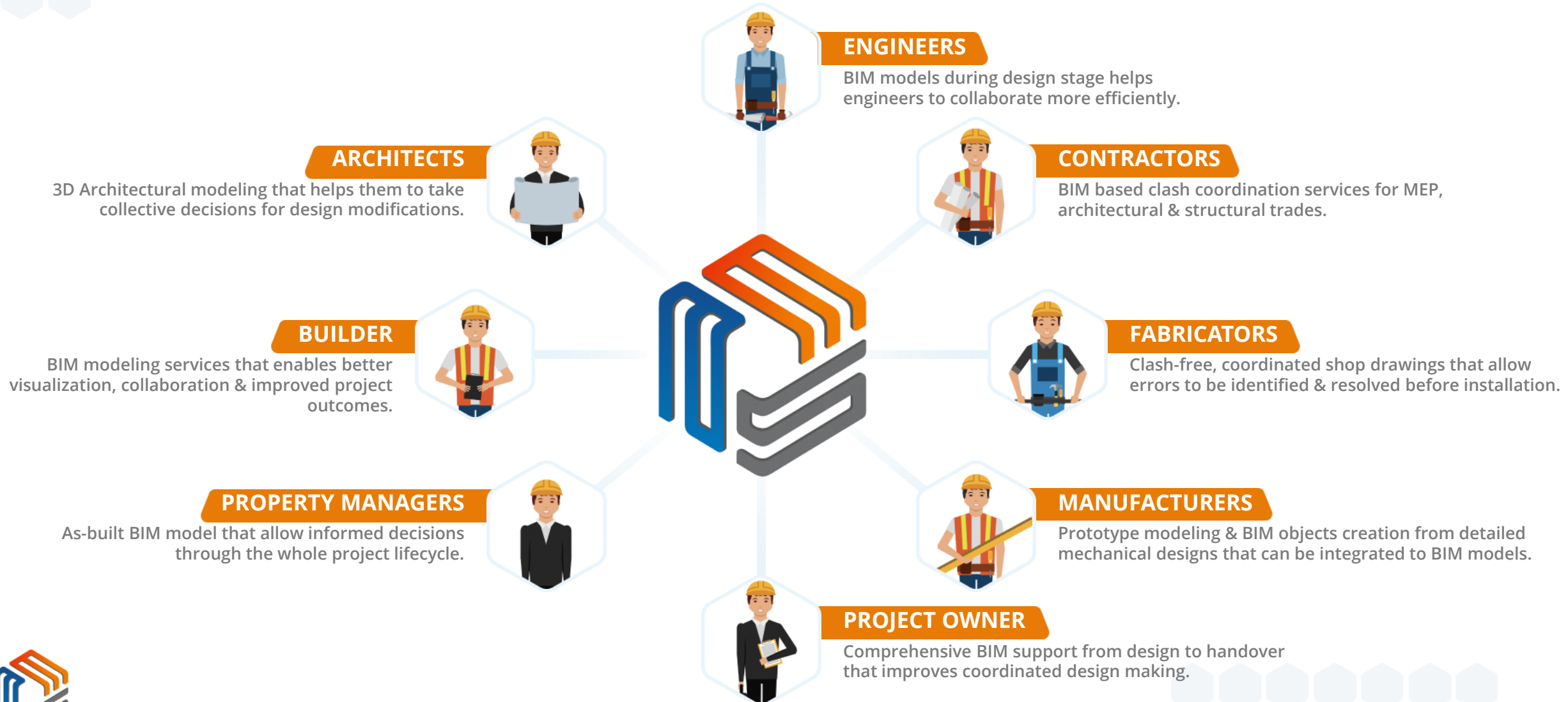

# ARCHITECTURAL MODELING

Intelligent visualization of projects with broad level of details and calculations to improve the quality of delivery and turnaround the time.

**ARCHITECTURAL BIM**

**SHOP DRAWING CREATION**

**DESIGN DEVELOPMENT**

**CONSTRUCTION DOCUMENTATION**

**POINT CLOUD MODELING**





# MEP & HVAC BIM

We place ourselves before the AEC industry as a conversant workforce of MEP/HVAC engineers providing MEP BIM services to various sectors which include educational institutions, healthcare, plants, residential, commercial and industrial buildings.

**3D COORDINATION & CLASH REPORT**

**SHOP & FABRICATION DRAWING**

**DESIGN DEVELOPMENT**

**POINT CLOUD MODELING**

**SPOOL DRAWING**

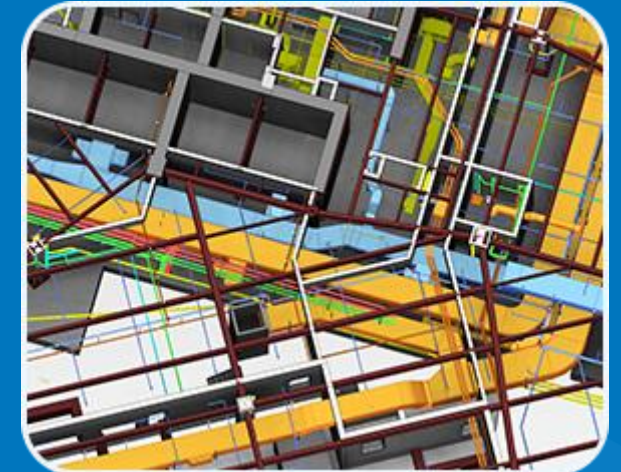
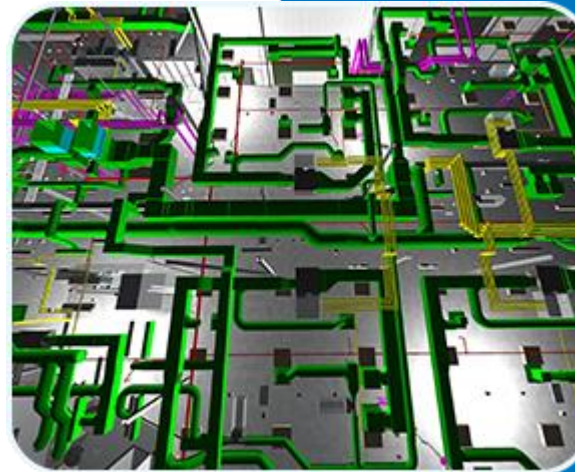
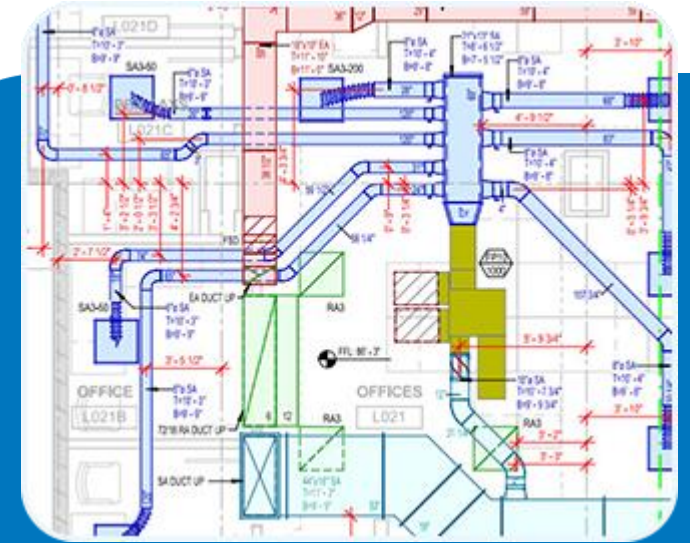
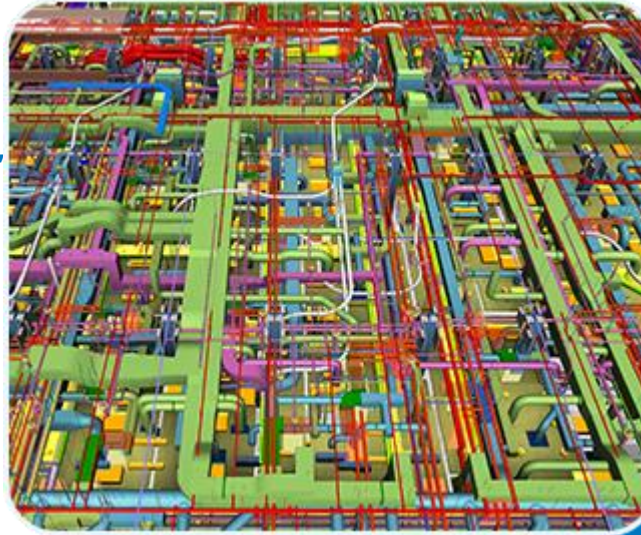

# STEEL, PRECAST & REBAR DETAILING

An established lineup of effective detailing services to ensure effective management of design and project constructability for reduced cost of installation and business growth.

**STRUCTURAL STEEL DETAILING**

**PRECAST DETAILING**

**REBAR DETAILING, BAR BENDING LIST**

**CONCRETE DETAILING**

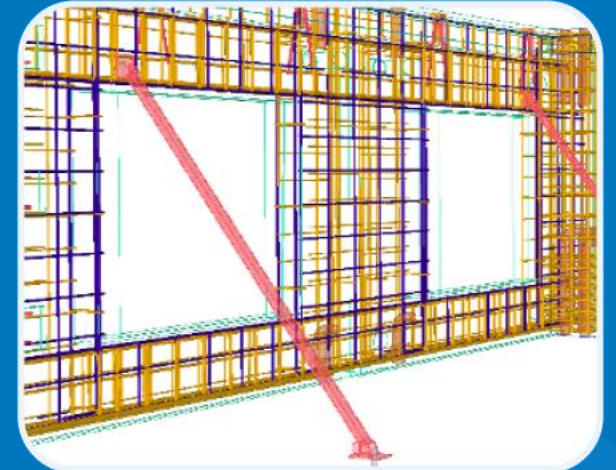
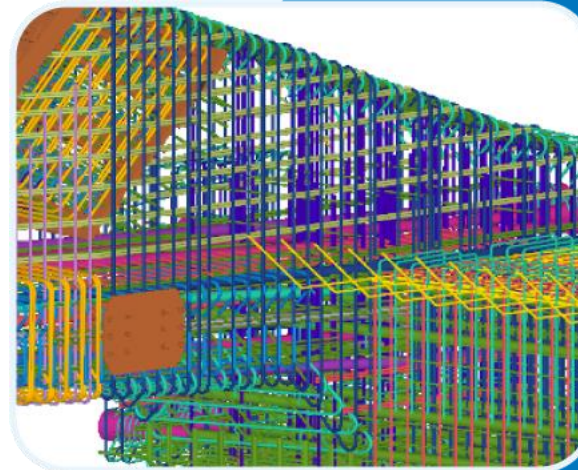
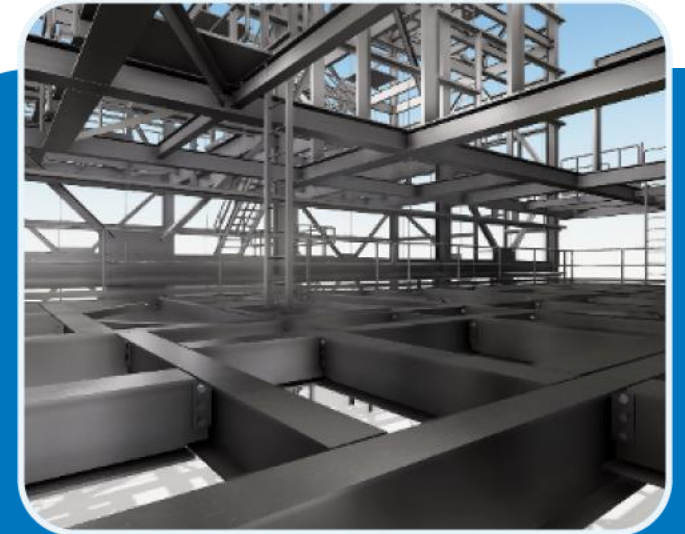
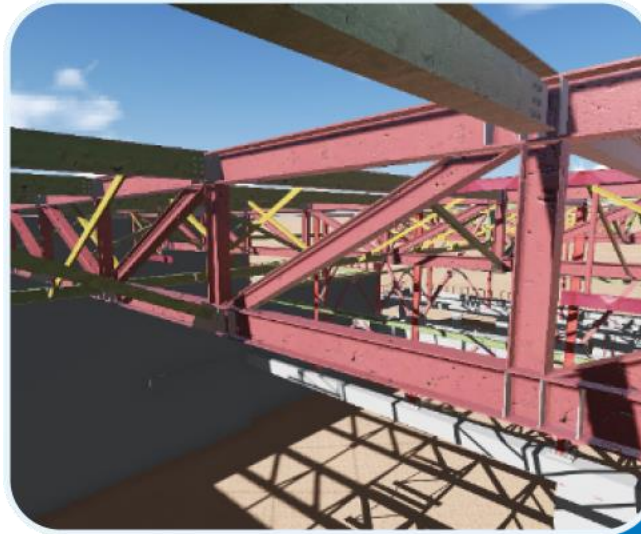

# FACADE ENGINEERING SERVICES

Accurate shop & fabrication drawings enabling clients to plan for optimized & balanced production of building envelope systems

**CURTAIN WALLS**

**SPIDER GLAZING**

**SHOP FRONTS & FRAMELESS GLASS**

**METAL PANELS & HAND RAILS**

**SKY LIGHTING & CANOPIES**

**WINDOWS, SLIDING/PARTITION DOORS**

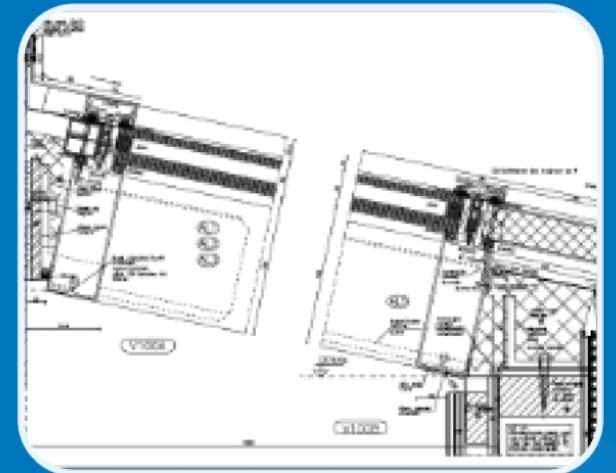
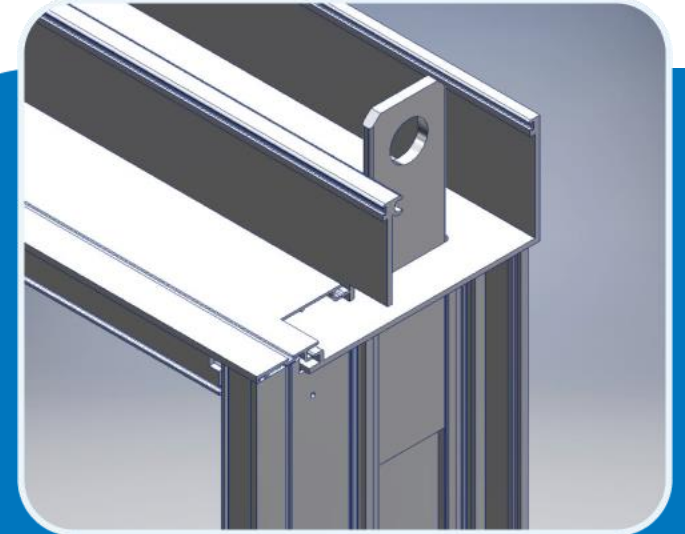
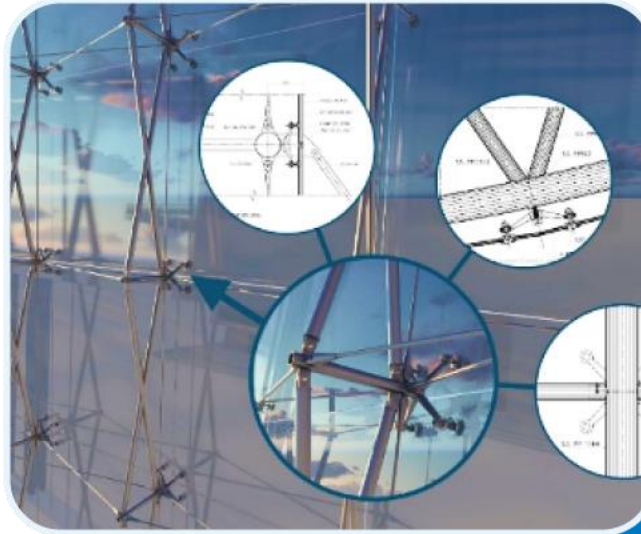

# CLASH DETECTION & RESOLUTION

Seamless coordination of MEP with Architecture & Structural trades, allowing all systems to work in perfect synchronization and at the same time maintaining the design intent

**ARCHITECTURAL BIM**

**STRUCTURAL BIM**

**MEP BIM**

**RESOLUTION OF CLASHES**

**ONLINE COORDINATION MEETINGS**

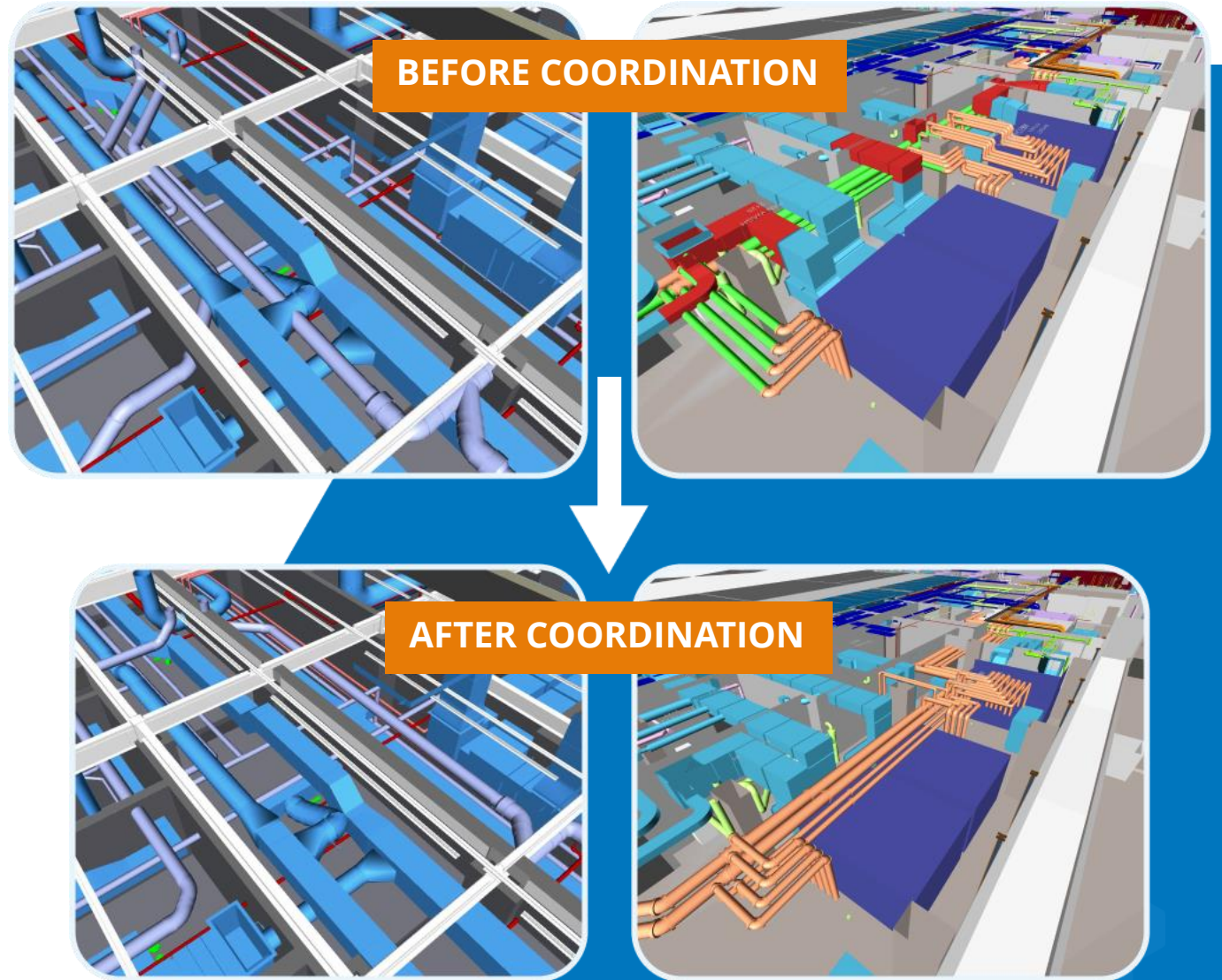

# INTEGRATED BIM PROJECT DELIVERY

Helping organizations leverage the potentials of BIM integrating architectural, structural, mechanical & plumbing systems

**ARCHITECTURAL BIM**

**STRUCTURAL 3D MODELING**

**HVAC & PLUMBING MODELING**

**BIM CLASH COORDINATION**

**SHOP/FABRICATION DRAWINGS**

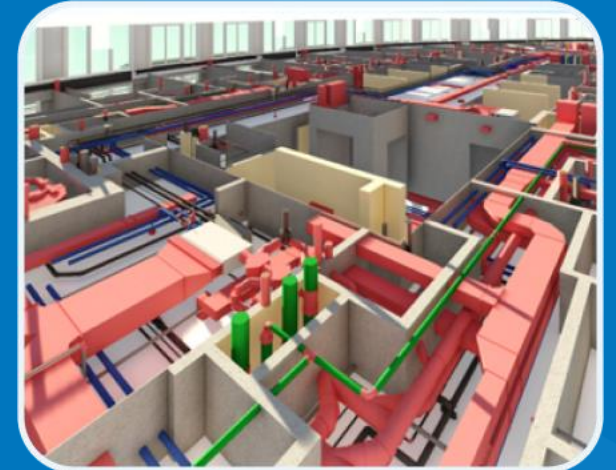
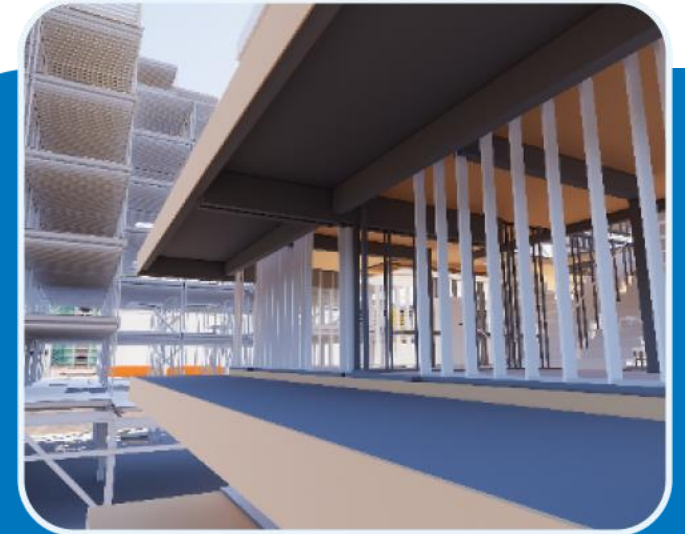
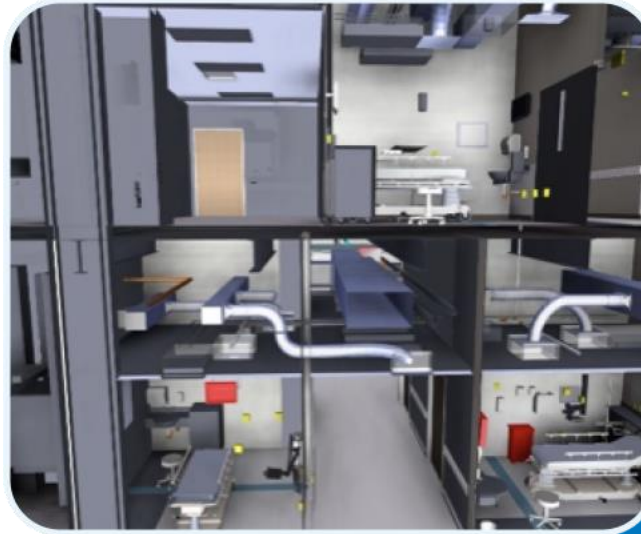

# INFRASTRUCTURE BIM

Integrated approach to model multi-disciplined trades for utility structures, power stations, water treatment plants, highways & bridges

**BRIDGE INFORMATION MODELING**

**BIM FOR WATER TREATMENT PLANTS**

**LANDSCAPE & SITE MODELING**

**TUNNEL INFORMATION MODELING**

**MARINE/OFFSHORE STRUCTURE MODELING**

**BIM FOR TRANSPORTATION**

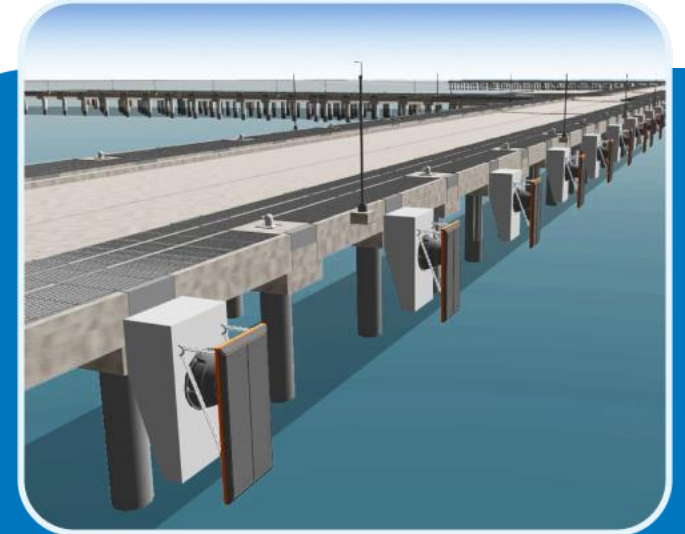
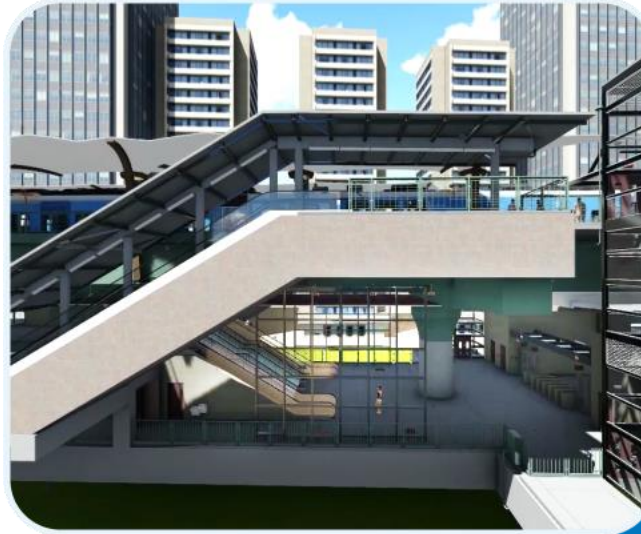

# MECHANICAL CAD/CAM

Our core expertise lies in providing 2D drafting & CAD 3D modeling services to clients for the fabrication & manufacturing of mechanical components.

**SHOP DRAWINGS**

**FABRICATION DRAWINGS**

**ASSEMBLY DRAWINGS**

**SHEET METAL DRAWINGS**

**ISOMETRIC DRAWING**

**PARAMETRIC MODELING**

**3D SOLID MODELING**

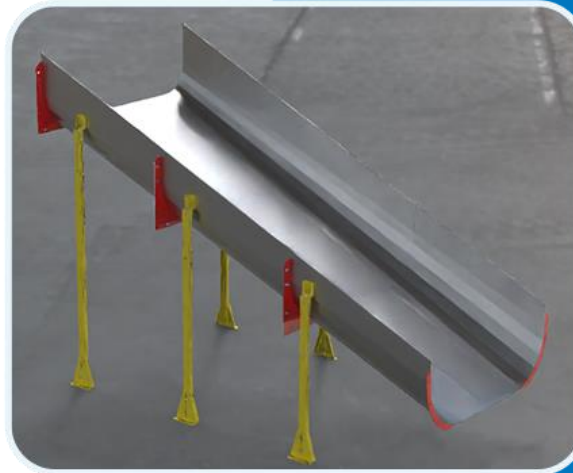
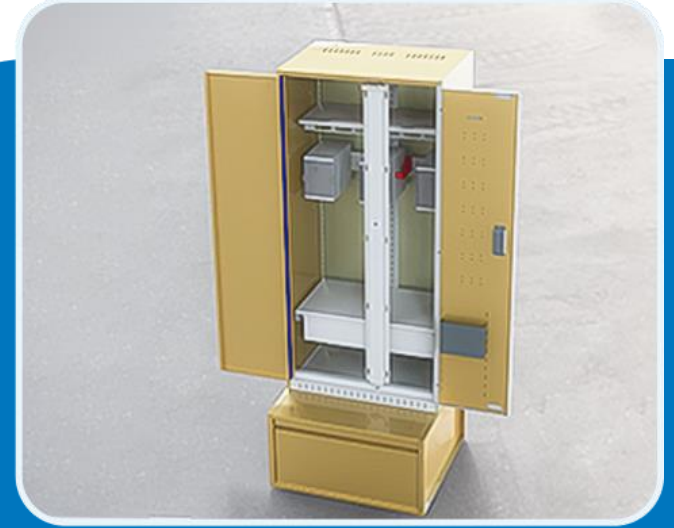

# INDUSTRIAL PLANT DIGITIZATION

We create intelligent 3D models for site preparation, structural design and detailing, building design, piping and equipment layout. Enhance and integrate multidisciplinary collaboration and minimize data loss across your project.

**LiDAR SCANNING**

**REVERSE ENGINEERING**

**SCAN TO DWG**

**AS-BUILT DOCUMENTATION**

**3D MODELING**

**LEGENDARY DRAWING**

**P & ID, GA & EQUIPMENT DRAWING**

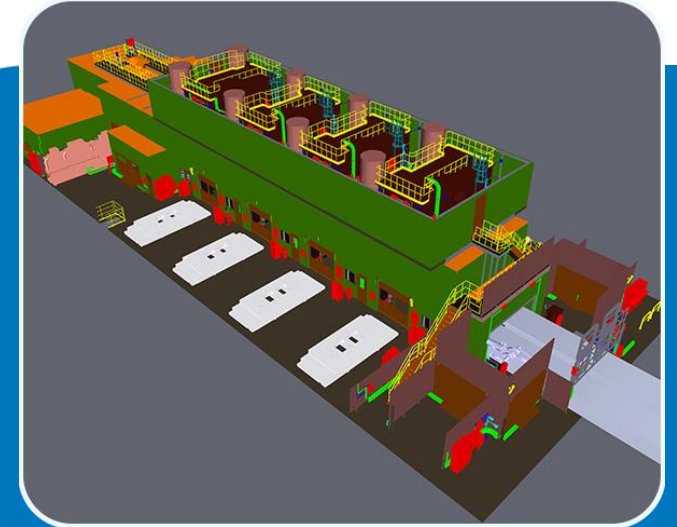



# POINTCLOUD SCAN TO BIM MODELING

The 3D BIM model that we create from laser scan data serve as accurate models for as-built purposes as well as for retrofit, refurbishment and renovation projects.

**ARCHITECTURAL CONVERSION**

**STRUCTURAL CONVERSION**

**MEP CONVERSION**

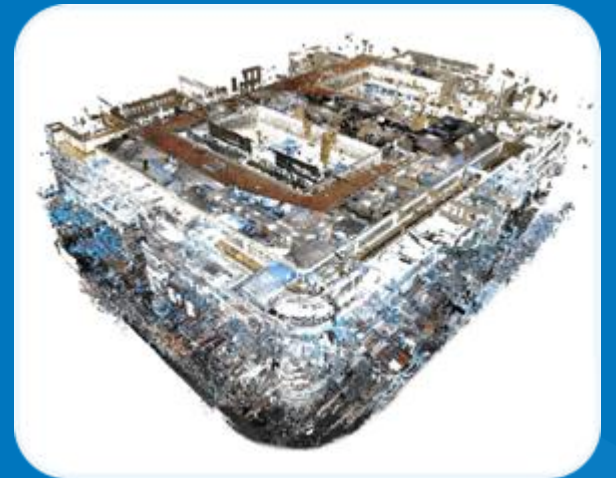

# REVIT FAMILY CREATION

Creation of standard and customized revit families for the retail, manufacturing and the construction industry from the manufacturer's submittals or even hand sketches.

**ARCHITECTURAL ELEMENTS**

**STRUCTURAL COMPONENTS**

**MECHANICAL FITTINGS**

**PLUMBING FIXTURES**

**PRODUCT LIBRARIES**

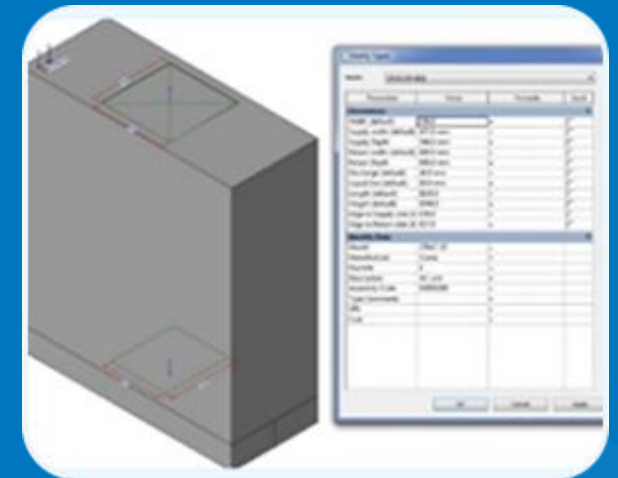
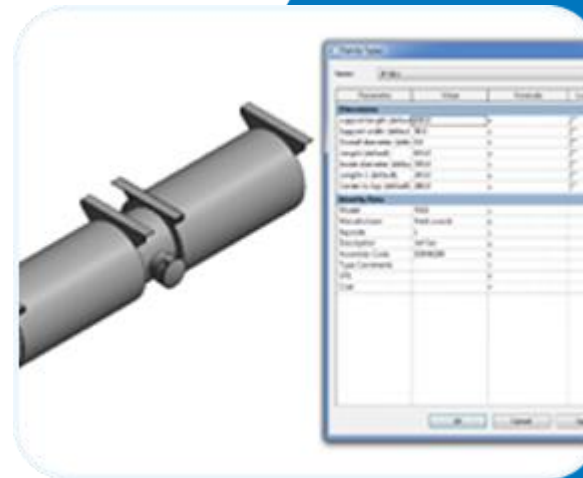
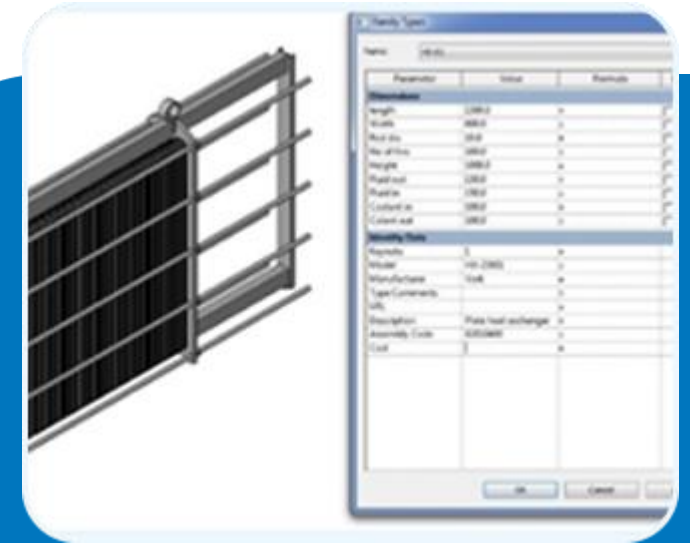
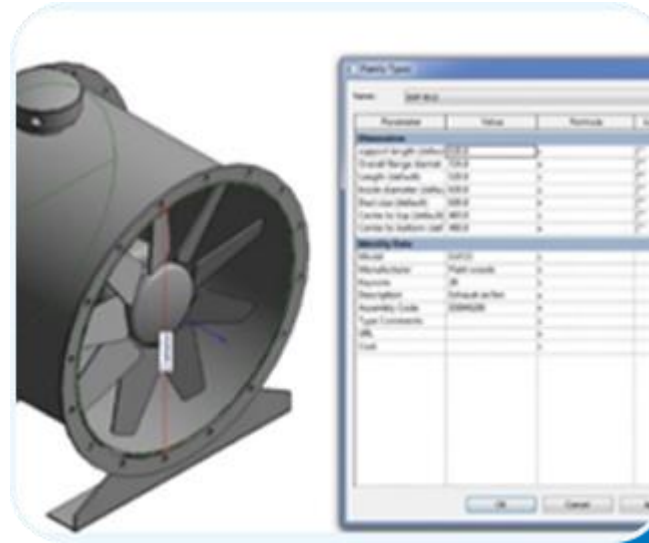

# BIM CONSULTING SERVICES

Since 2007, we have been assisting construction companies, general & specialty contractors in their migration to BIM from CAD. We act as a strategic BIM partner to the client educating and training them for seamless migration from CAD drafting to BIM implementation.

**BIM MODEL AUDIT**

**OFFSHORE BIM TEAM**

**BIM IMPLEMENTATION PLANNING**





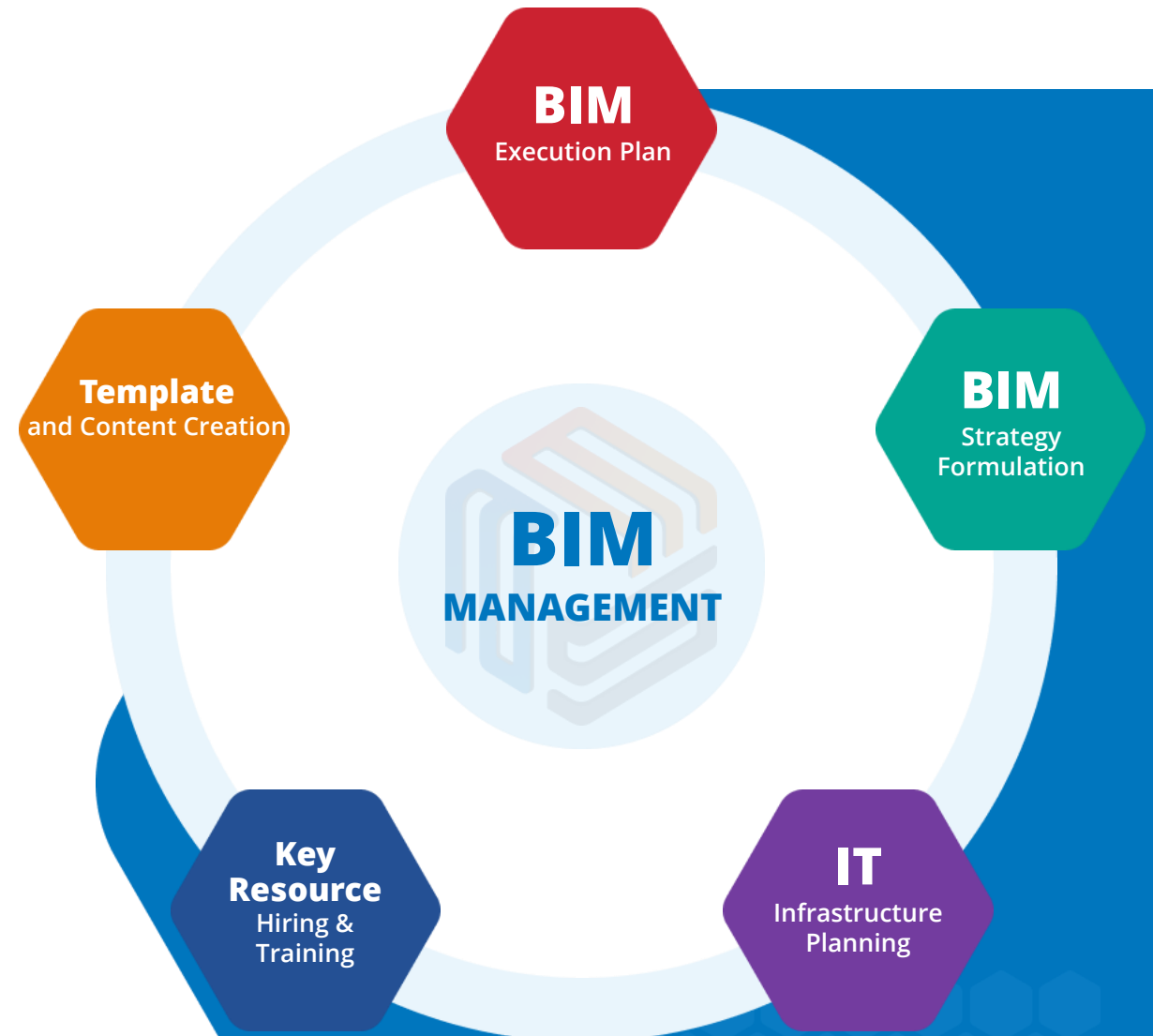



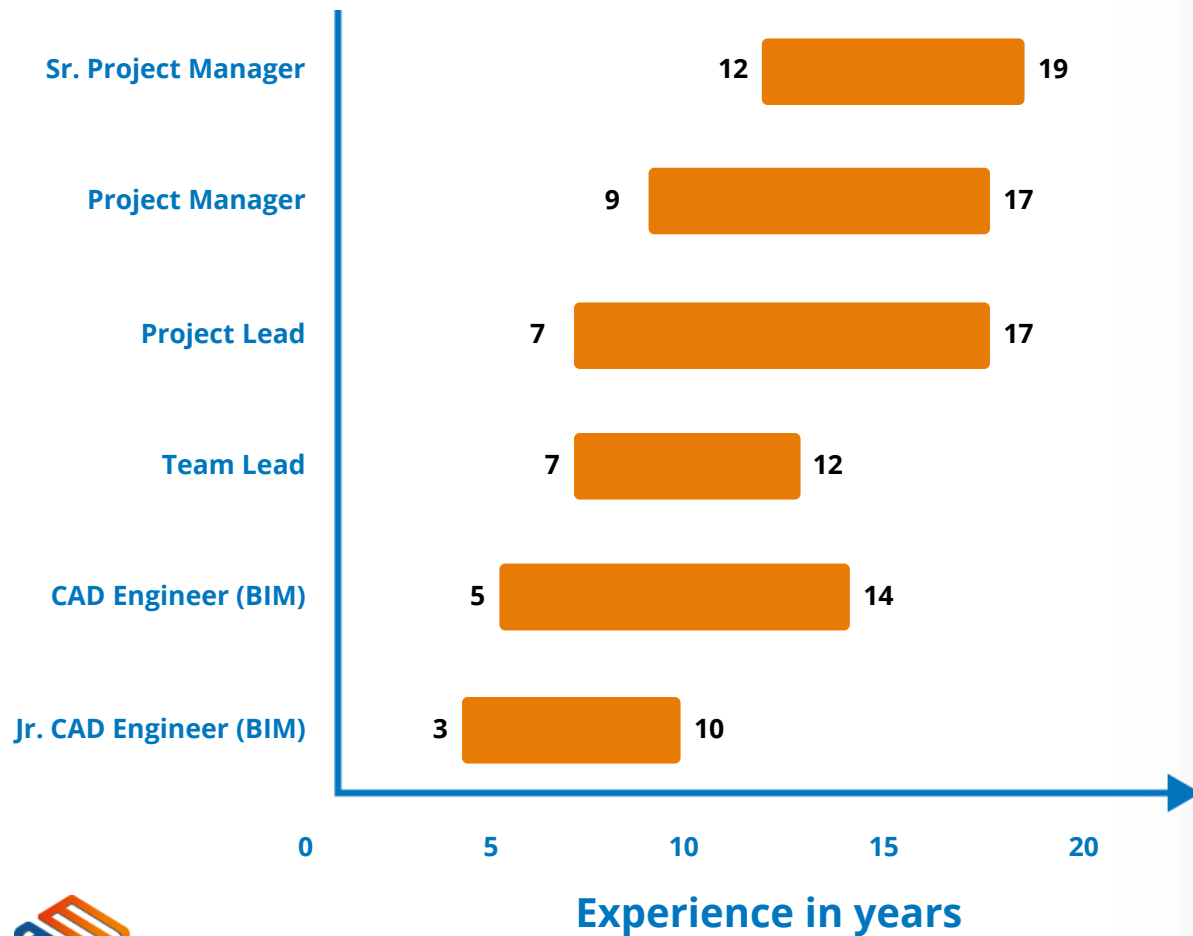

**BIM TRAINING**

**ON-SITE BIM SUPPORT**



# TEAM PROFICIENCY AND SOFTWARE PROFICIENCY



 Civil 3D	 FormIt Pro	 Construction Cloud
 InfraWorks	 Insight	 MagiCAD
 Revit	 3ds Max	 LogiKal
 ReCap Pro	 Inventor	 Tekla
 AutoCAD MEP	 Fabrication CADmep	 STAAD.Pro
 Autodesk Docs	 Advance Steel	 Solid Edge
 Navisworks Manage	 AutoCAD Plant 3D	 RebarCAD
 Dynamo	 BIM Collaborate Pro	 RGS REBAR
 Trimble EC CAD, Field Technology	 Building Data	 Rhinceros

# BIM TRAINING & CERTIFICATE PROGRAM

A Certificate Program in Building Information Modeling (BIM) is available at East Stroudsburg University (ESU) through a partnership between ESU and Advenser Technology Services, Inc. (Advenser).



EXPLORE  
OUR  
COURSES



BIM for  
Beginners



BIM Proficiency  
Training



BIM for Building Utility  
Services



BIM Manager  
Training

BIM for Structural  
Engineering

BIM for Facade  
Engineering

BIM for Steel  
Detailing

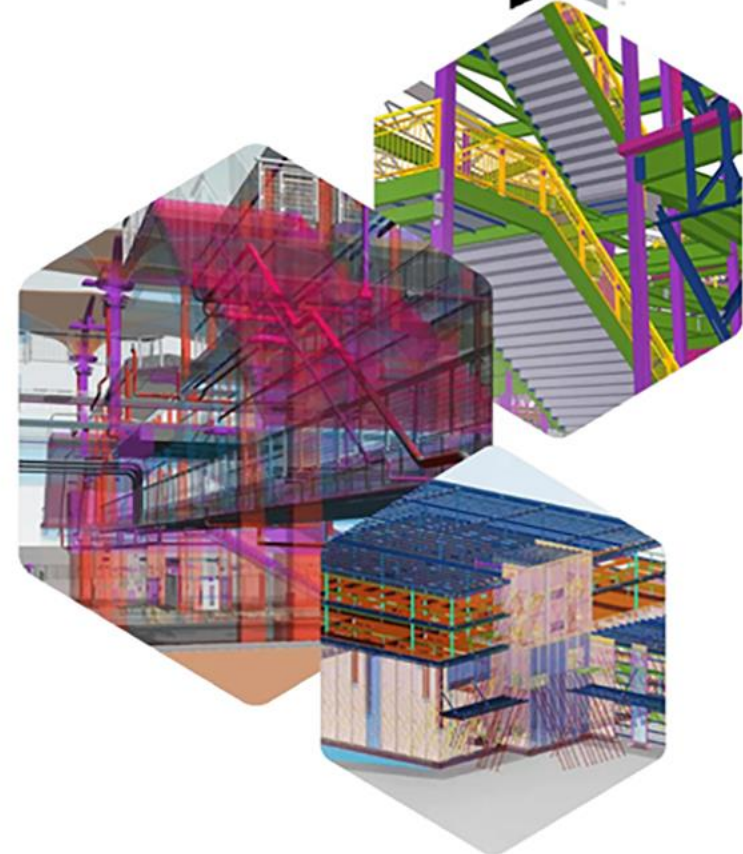

Accredited by



# CONTACT US



## **Advenser Technology Services, Inc.**

Five Neshaminy Interplex, STE 205  
Trevose, PA 19053, USA

Phone: +1 (215) 791 7955



## **Advenser LLC**

Five Neshaminy Interplex, STE 205  
Trevose, PA 19053, USA

Phone: +1 (215) 934 2868



## **Advenser Engineering Services Pvt. Ltd.**

43 A, E block, 4F CSEZ, Kakkanad  
Kochi, Kerala, India. Pin 682 037

Phone: +91 484 298 8448



## **Advenser Engineering Systems LLC**

P.O. Box No: 118901,  
Dubai, UAE

Phone: +971 50 237 7430



## **Advenser Engineering Services Pty. Ltd.**

Unit 26, 14 Jubilee Avenue  
Warriewood NSW 2102, Australia

Phone: +61 363 877 090



## **Advenser Engineering Services Pvt. Ltd.**

403, 4F, Lulu Cyber Tower 1, Infopark  
Kochi, Kerala, India. Pin 682 042

Phone: +91 484 404 0708



[www.advenser.com](http://www.advenser.com)



[info@advenser.com](mailto:info@advenser.com)

**THANK YOU**

