



WHO WE ARE

Established in 2007, Advenser helps construction companies, general contractors, architects & engineers, integrate BIM into their projects seamlessly within their predefined timelines and budget, bridging the gap between concept & constructability.

Mission

To provide services to customers globally with cutting edge technologies and guaranteed cost savings.

Vision

To be recognized as a leading Business Process Outsourcing service provider delivering exemplary services.



ADVENSER DIFFERENTIATORS



**Digital Twin / Brownfield
Project Solutions**



System Driven Best Project Practice



State-of-the-art Infrastructure



Refined Quality Assurance Procedure



Scalability & Flexibility of Resources



Qualified & Specialized Resources



INDUSTRY / SECTORS / VERTICLES



OIL & GAS



WATER TREATMENT



INFRASTRUCTURE



GAS & STEAM TURBINES



CHEMICAL



OFFSHORE

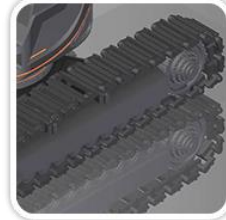

AUTOMOBILE

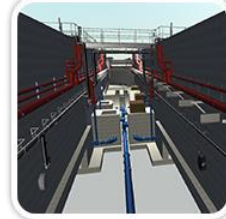

FACTORIES



LOCOMOTIVE

MARINE

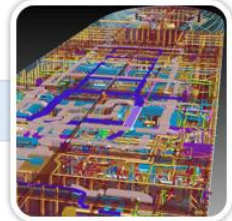

AEROSPACE



FILMS - LiDAR SCAN



HERITAGE



INDUSTRIAL / PLANT DIGITIZATION SERVICES



**LiDAR Scanning/
Registration**



**2D to 3D
Conversions**



**Process Schematic
Diagram**



**As-Built
Documentation**

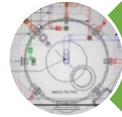

**Spool & Fabrication
Drawings**



**P & ID
Diagrams**



**Point Cloud to
DWG/Plant 3D/
COE/REVIT**



**Bill of
Materials**

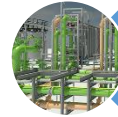

**GA & Equipment
Layout**



**Legendry
Conversion**

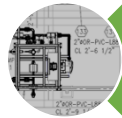

**Process Flow
Drawings**

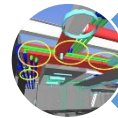

**Clash Detection &
Report Generation**



REFERENCE WORKFLOW - PLANT

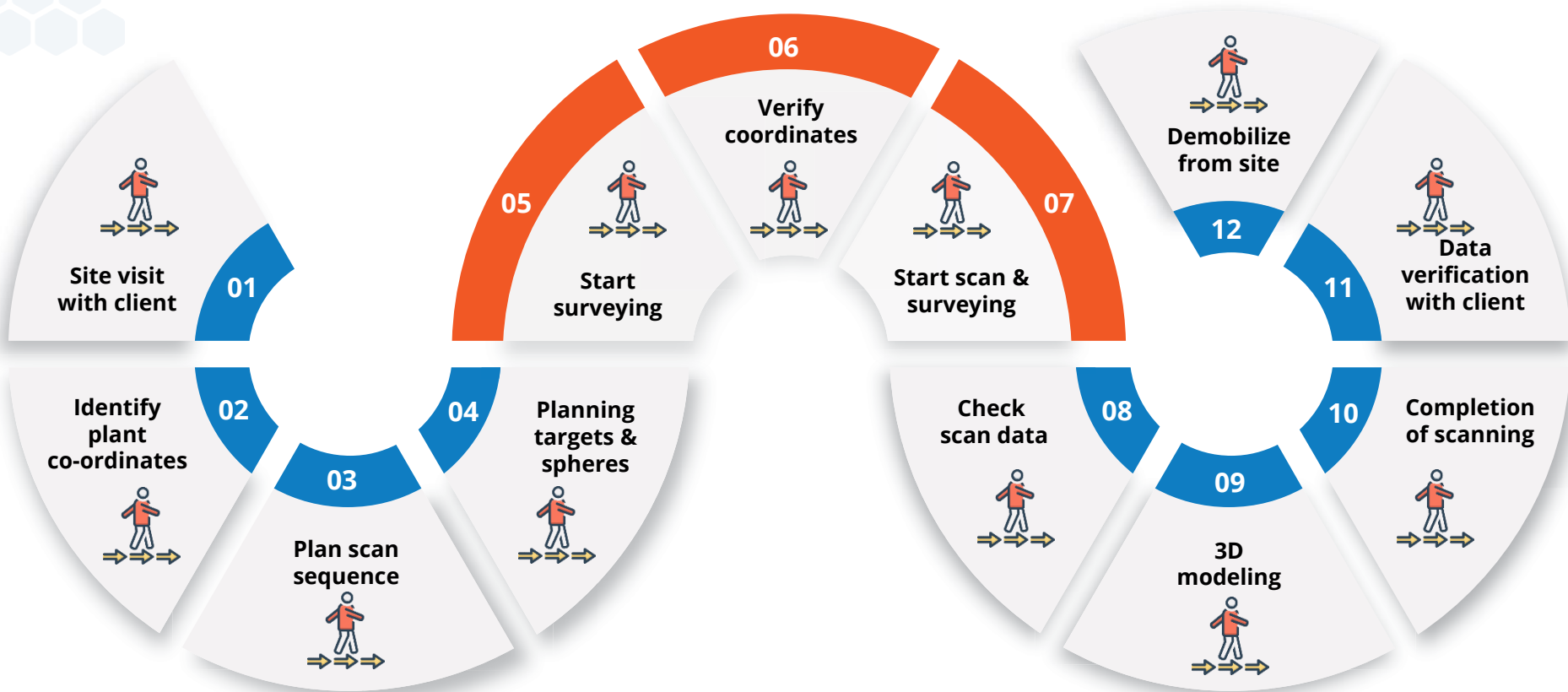

POINT CLOUD TO 3D MODEL CONVERSION



BILL OF MATERIALS

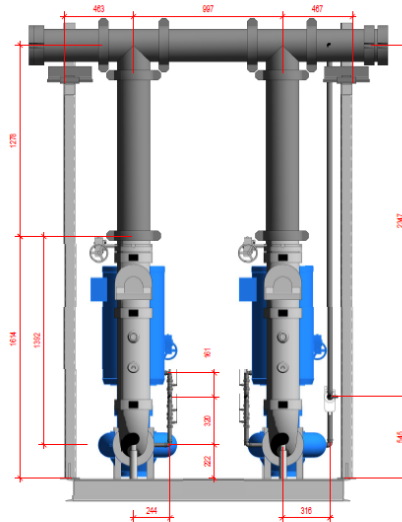
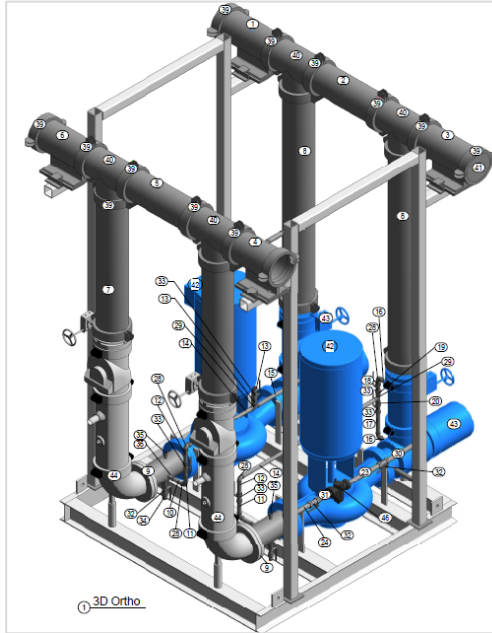

MEP Fabrication Pipework Schedule						
Mark	Size	Description	End Prep	Length (mm)	Qty	
1	200e	PIPE 316L SS SCH 10	GWGV	460	1	
2	200e	PIPE 316L SS SCH 10	GWGV	562	1	
3	200e	PIPE 316L SS SCH 10	GWGV	465	1	
4	200e	PIPE 316L SS SCH 10	GWGV	374	1	
5	200e	PIPE 316L SS SCH 10	GWGV	562	1	
6	200e	PIPE 316L SS SCH 10	GWGV	437	1	
7	200e	PIPE 316L SS SCH 10	GWGV	1070	2	
8	200e	PIPE 316L SS SCH 10	GWGV	1718	2	
9	150e	PIPE 316L SS SCH 10	BWBW	372	2	
10	20e	PIPE 316L SS SCH 10-THRD	THRD/THRD	108	2	
11	20e	PIPE 316L SS SCH 10-THRD	THRD/THRD	118	2	
12	20e	PIPE 316L SS SCH 10-THRD	THRD/THRD	126	2	
13	20e	PIPE 316L SS SCH 10-THRD	THRD/THRD	50	4	
14	20e	PIPE 316L SS SCH 10-THRD	THRD/THRD	618	2	
15	20e	PIPE 316L SS SCH 10-THRD	THRD/THRD	619	2	
16	20e	PIPE 316L SS SCH 10-THRD	THRD/THRD	112	4	
17	20e	PIPE 316L SS SCH 10-THRD	THRD/THRD	169	2	
18	20e	PIPE 316L SS SCH 10-THRD	THRD/THRD	42	2	
19	20e	PIPE 316L SS SCH 10-THRD	THRD/THRD	43	2	
20	20e	PIPE 316L SS SCH 10-THRD	THRD/THRD	45	2	
21	25e	PIPE 316L SS SCH 10-THRD	THRD/THRD	225	1	
22	25e	PIPE 316L SS SCH 10-THRD	THRD/THRD	251	1	
23	25e	PIPE 316L SS SCH 10-THRD	THRD/THRD	315	1	
24	25e	PIPE 316L SS SCH 10-THRD	THRD/THRD	220	1	
25	25e	PIPE 316L SS SCH 10-THRD	THRD/THRD	2305	1	
26	25e	PIPE 316L SS SCH 10-THRD	THRD/THRD	154	1	
27	25e-25e	THREADED DES ELBOW-SS-SCH 10			4	
28	20e-20e	THREADED W DES ELBOW-SS-SCH 10			8	
29	20e-20e-20e	THREADED TEE-SS-SCH 10			34	4
30	25e	PIPE 316L SS SCH 10-THRD	THRD/THRD	267	1	
31	25e	PIPE 316L SS SCH 10-THRD	THRD/THRD	126	1	
32	25e-25e	BALL VALVE		42	4	
33	20e-20e	BALL VALVE		16	8	
34	25e	PIPE 316L SS SCH 10-THRD	THRD/THRD	48	4	
35	150e-15e	THREAD-OLET		125	2	
36	150e-20e	THREAD-OLET		125	2	
37	200e-25e	THREAD-OLET		190	1	
38	150e-25e	THREAD-OLET		125	2	
39	200e-200e	VC QUICKVIC COUPLING STYLE 107N (RIGID)		67	20	
40	200e-200e-200e	VC TEE SS		396	4	
41	200e	VC END CAP SS			2	
42		P.PRP1443.04			2	
43	200e-150e	VC IPS SUCTION VIBRATION ISOLATION PUMP DROP S/381			2	
44	200e-150e	VC IPS DISCHARGE VIBRATION ISOLATION PUMP DROP S/380			2	



SPOOL AND FABRICATION DRAWINGS

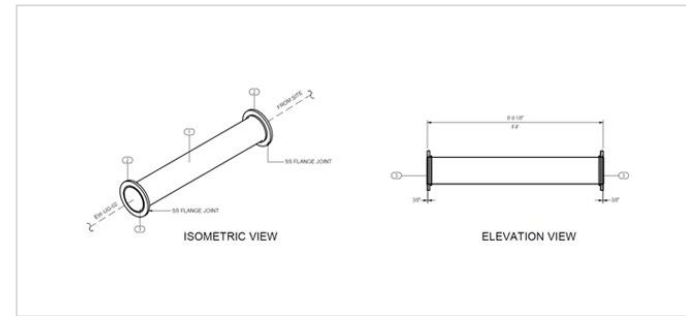
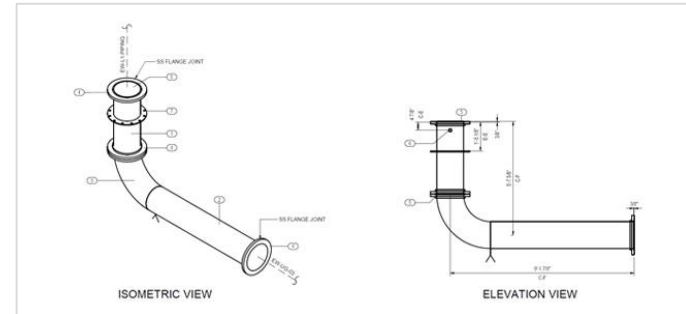
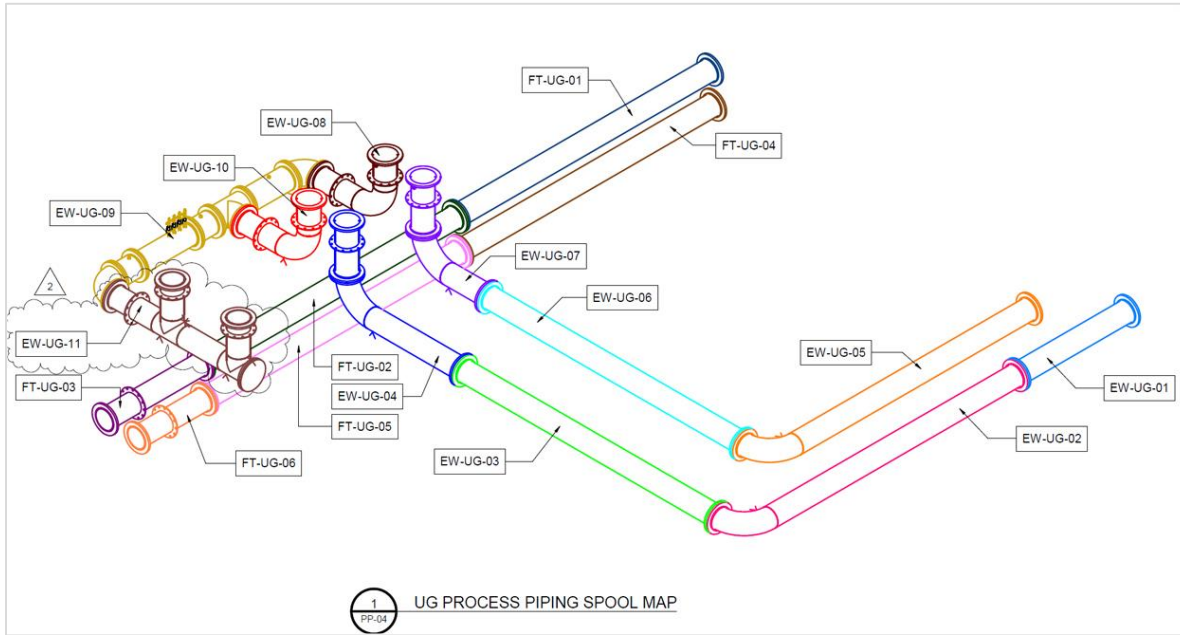

GA & EQUIPMENT LAYOUT

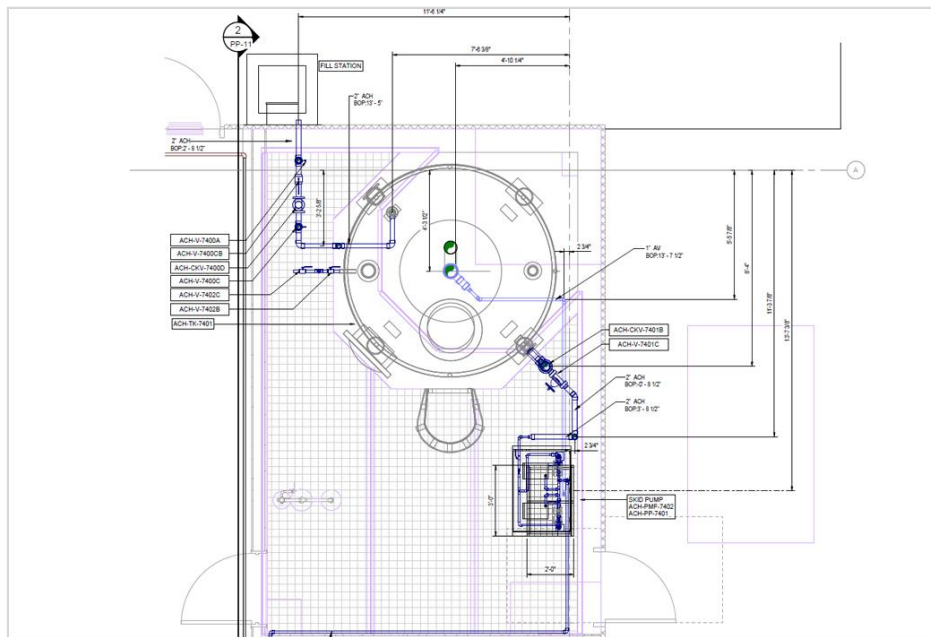
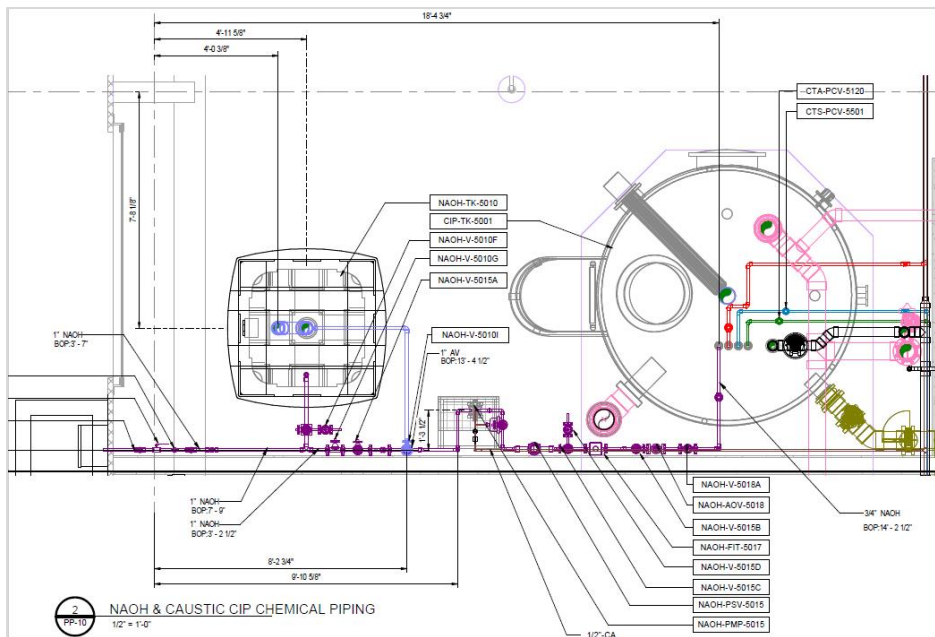

P & I DIAGRAM

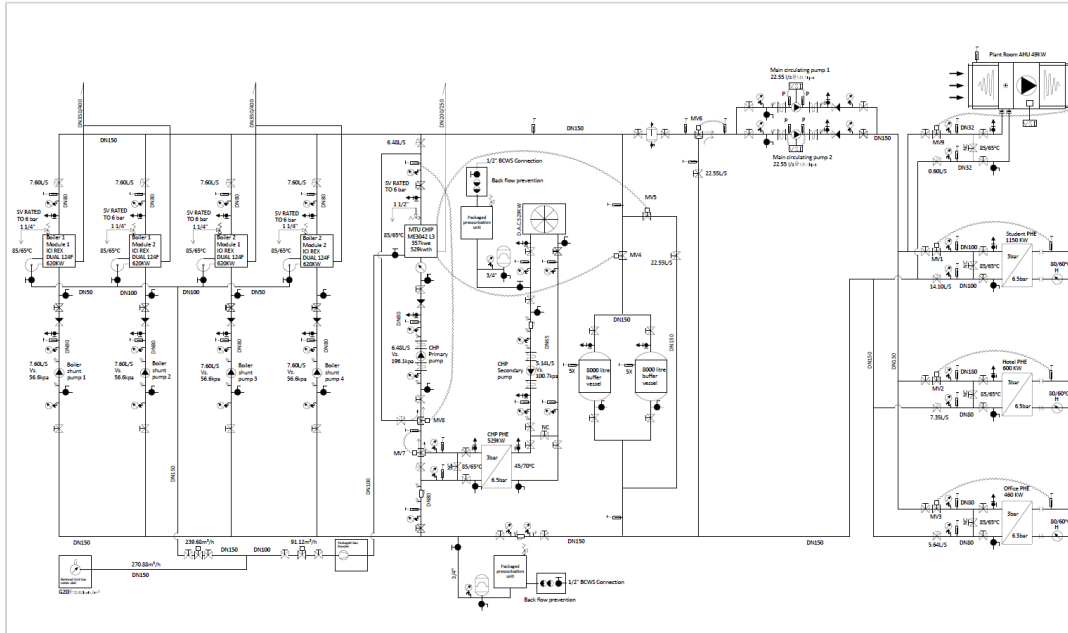

STRUCTURAL 3D MODELING SERVICES

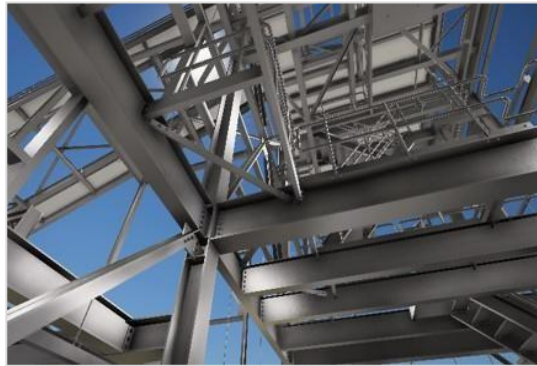
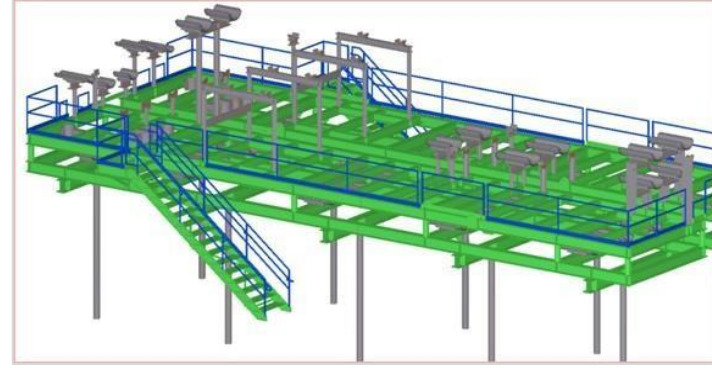
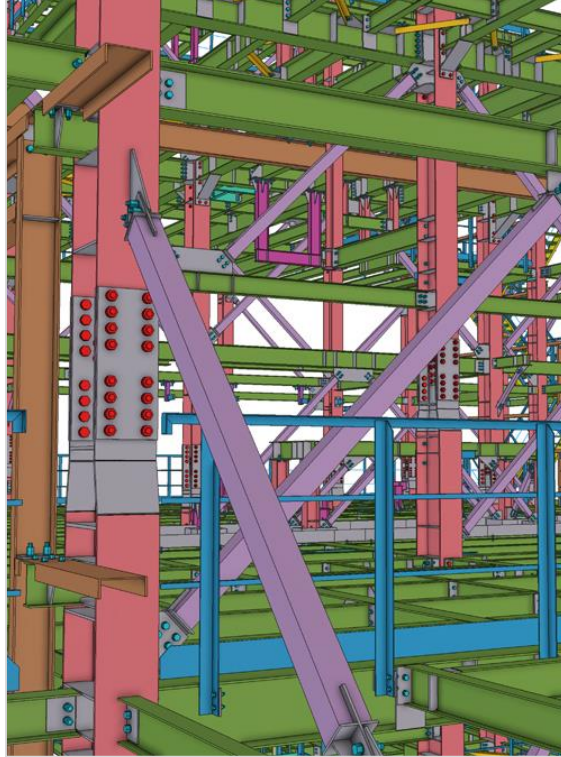

PROCESS PIPING DRAWINGS

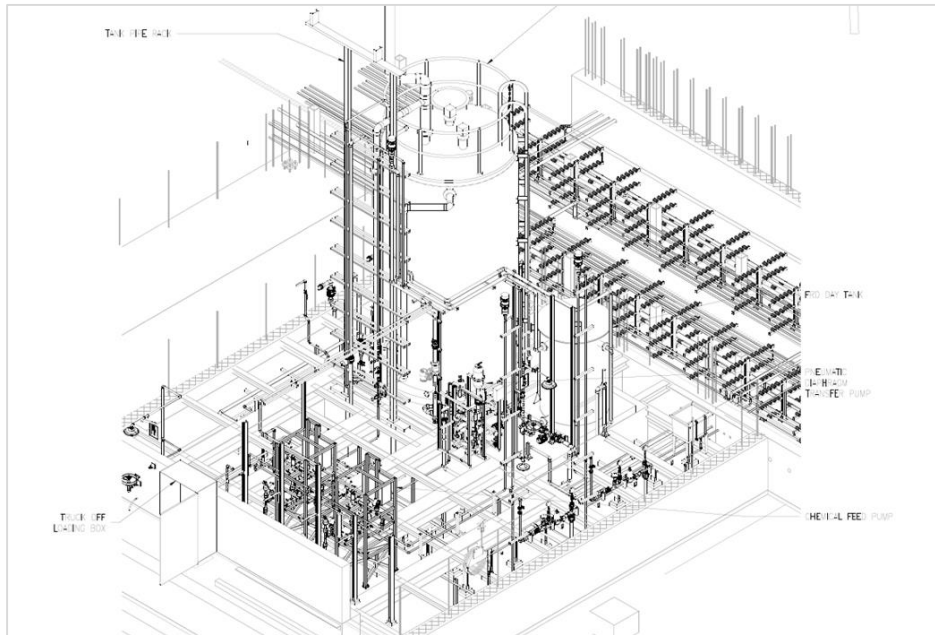
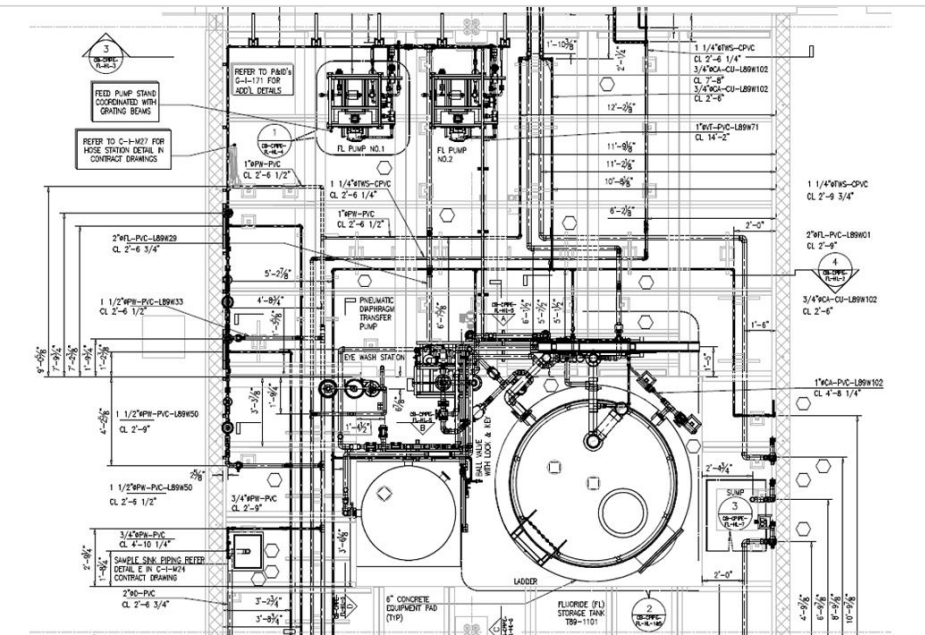

FEATURED PROJECTS

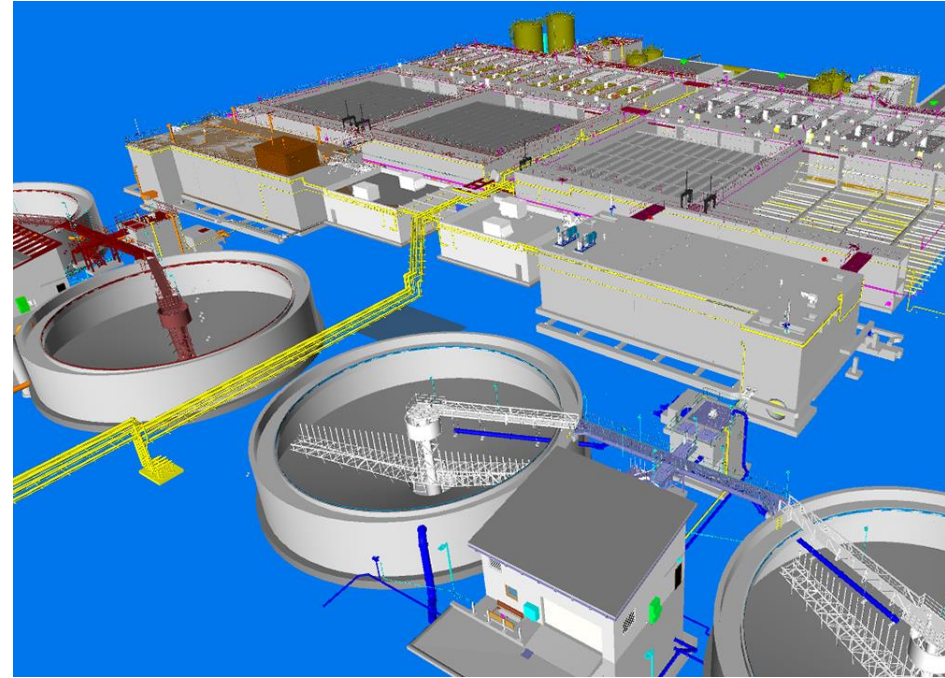

Water Purification Plant, Texas, USA



FEATURED PROJECTS

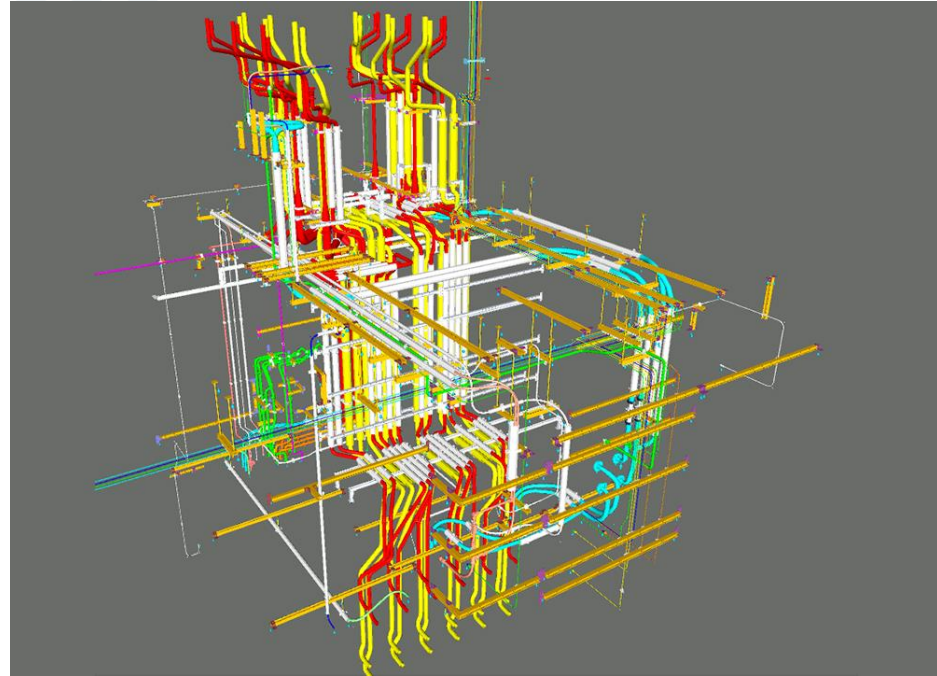

Data Center, Ireland



FEATURED PROJECTS

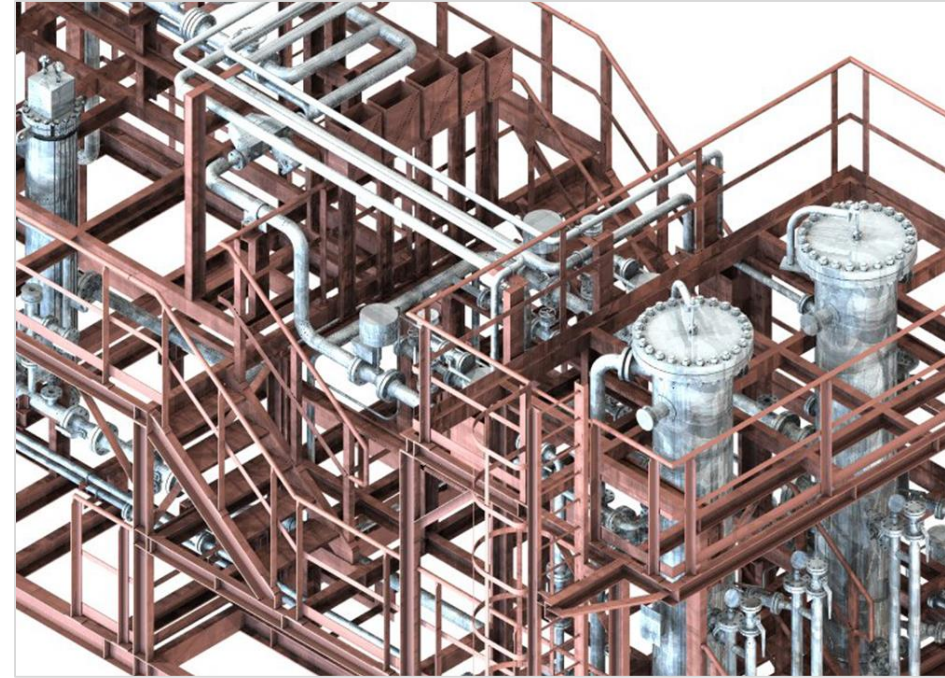
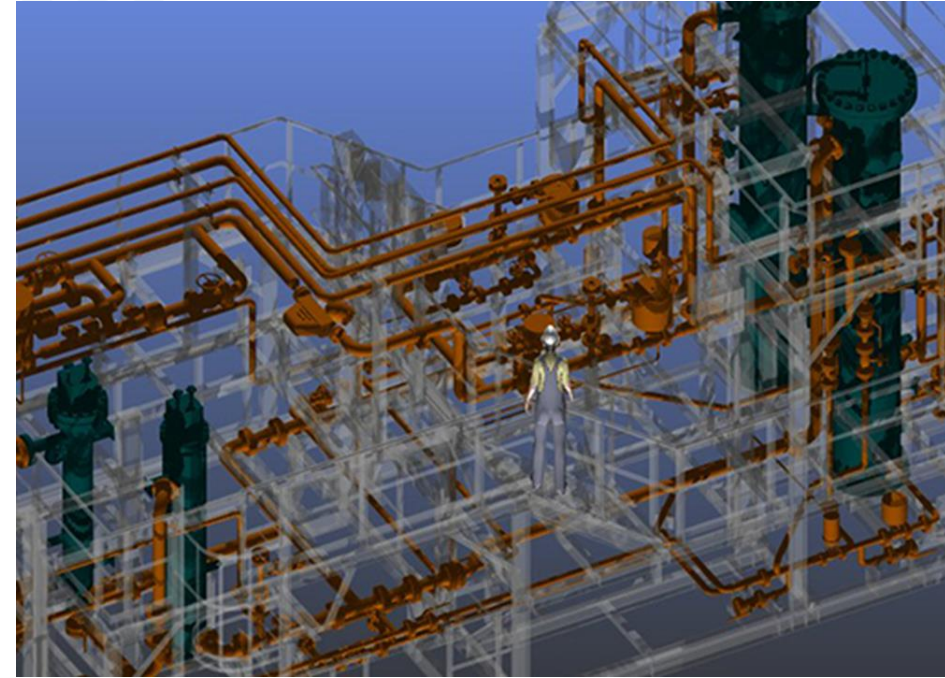

Oil and Gas Facility, Australia



FEATURED PROJECTS

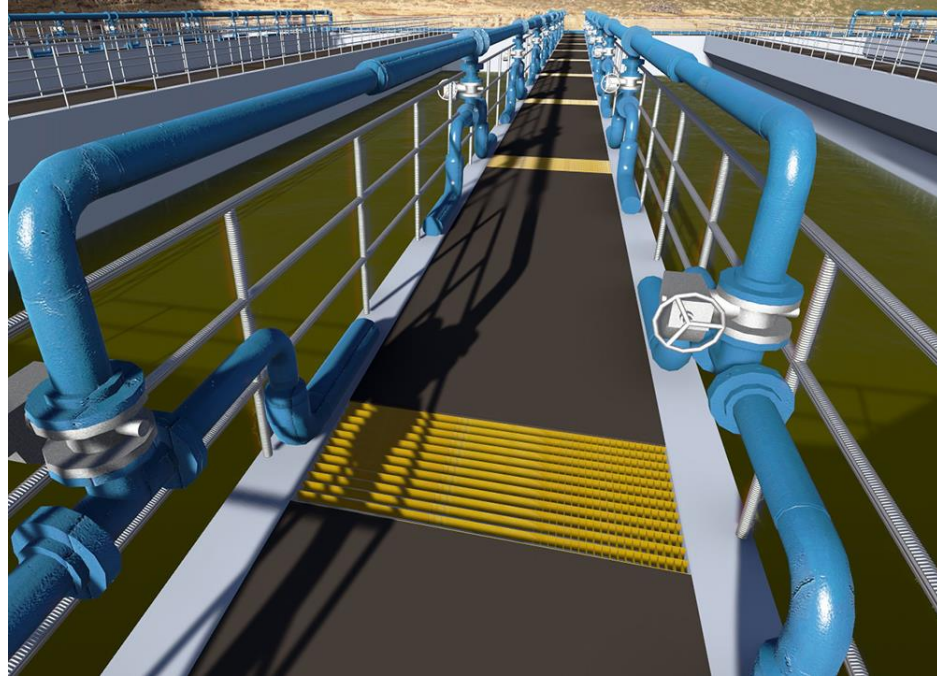

Water Treatment Plant, CA, USA



TEAM PROFICIENCY AND SOFTWARE PROFICIENCY

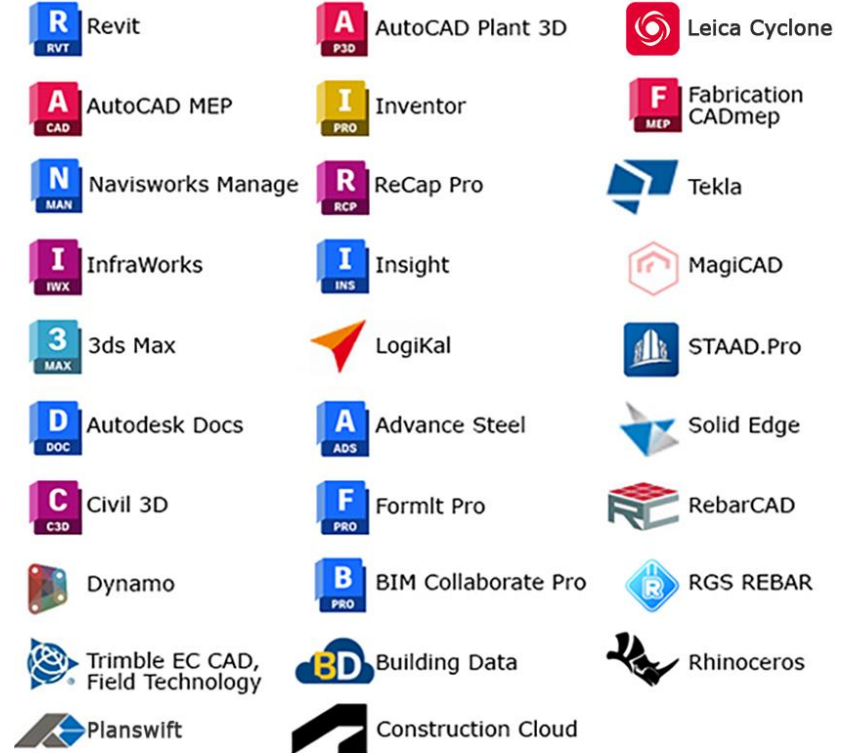
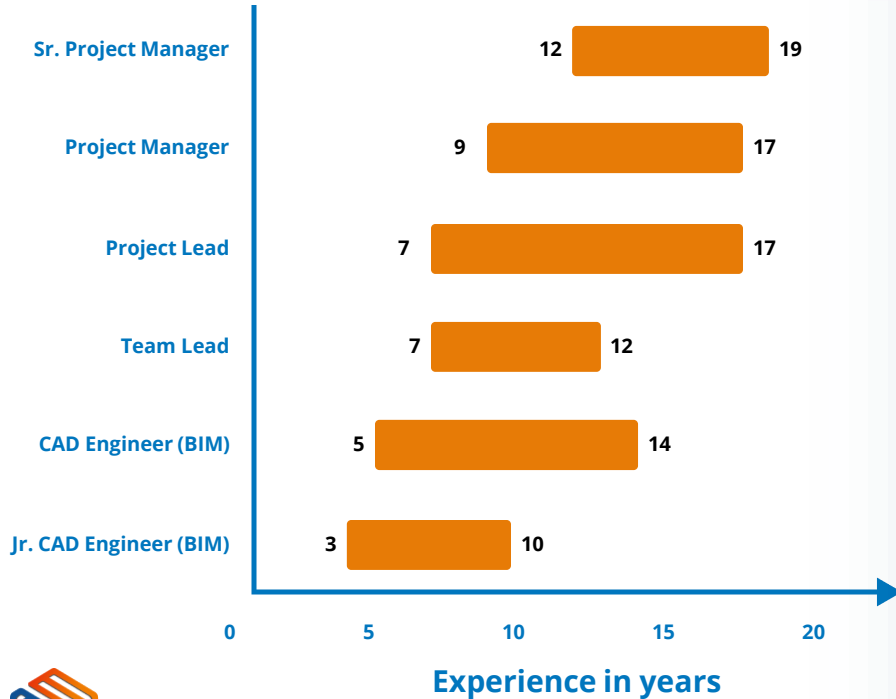

CONTACT US



Advenser Technology Services, Inc.

Five Neshaminy Interplex, STE 205
Trevose, PA 19053, USA
Phone: +1 (215) 791 7955



Advenser LLC

Five Neshaminy Interplex, STE 205
Trevose, PA 19053, USA
Phone: +1 (215) 934 2868



Advenser Engineering Services Pvt. Ltd.

43 A, E block, 4F CSEZ, Kakkanad
Kochi, Kerala, India. Pin 682 037
Phone: +91 484 298 8448



Advenser Engineering Systems LLC

P.O. Box No: 118901,
Dubai, UAE
Phone: +971 50 237 7430



Advenser Engineering Services Pty. Ltd.

Unit 26, 14 Jubilee Avenue
Warriewood NSW 2102, Australia
Phone: +61 363 877 090



Advenser Engineering Services Pvt. Ltd.

403, 4F, Lulu Cyber Tower 1, Infopark
Kochi, Kerala, India. Pin 682 042
Phone: +91 484 404 0708



www.advenser.com



info@advenser.com

www.advenser.com

THANK YOU



info@advenser.com