



WHO WE ARE

Established in 2007, Advenser helps construction companies, general contractors, architects & engineers, integrate BIM into their projects seamlessly within their predefined timelines and budget, bridging the gap between concept & constructability.

Mission

To provide services to customers globally with cutting edge technologies and guaranteed cost savings.

Vision

To be recognized as a leading Business Process Outsourcing service provider delivering exemplary services.



OUR CLIENT BASE

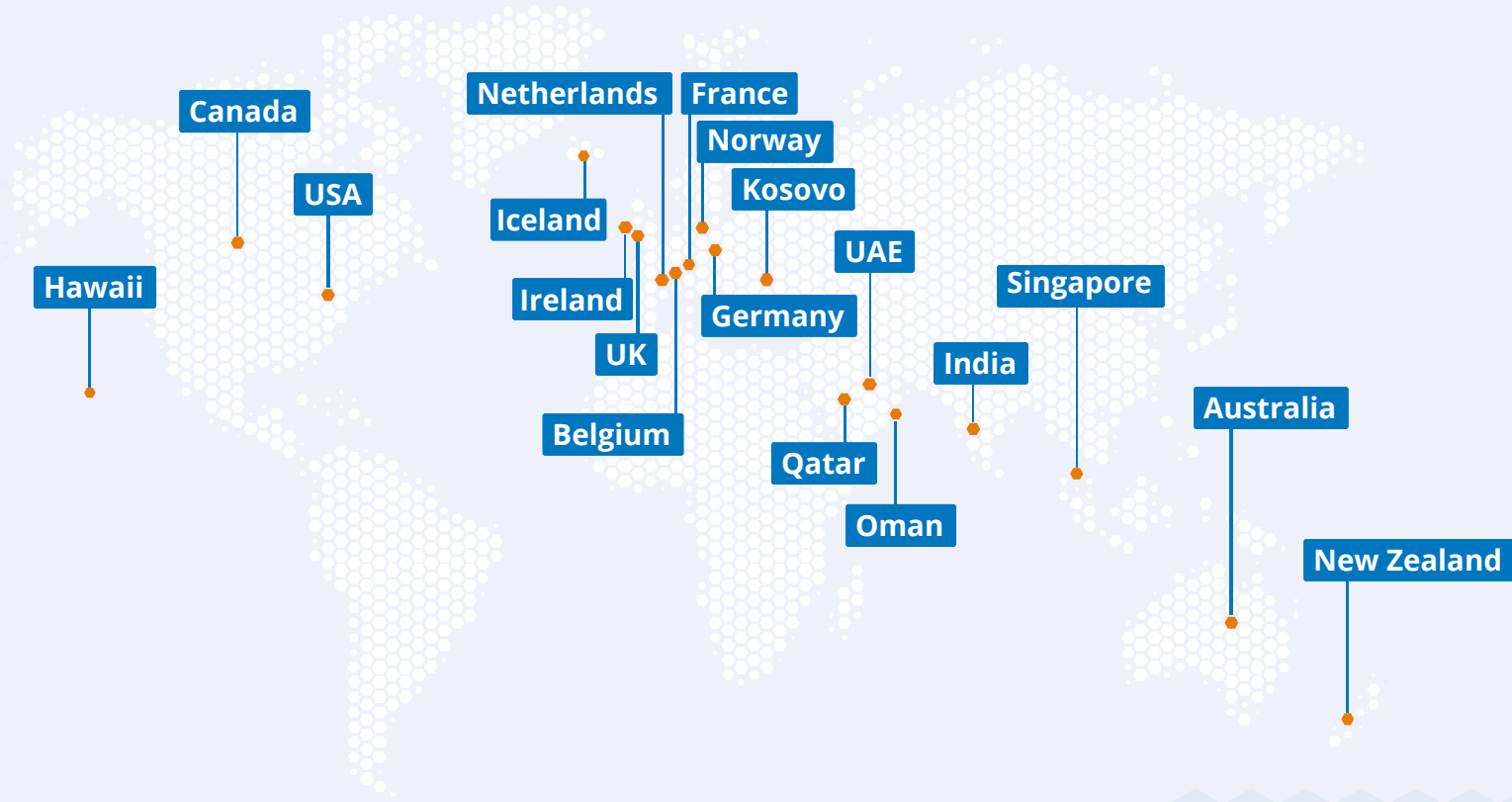

OUR MEP ENGINEERING SERVICES

HVAC & PLUMBING MODELING

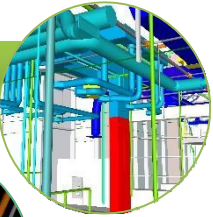

REVIT FAMILY CREATION



CLASH REPORT & RESOLUTION

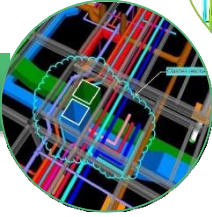

COBIE SERVICES

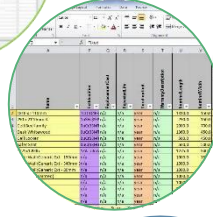

POINTCLOUD MODELING



INDUSTRIAL BIM

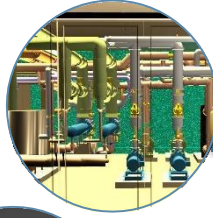

SPOOL DRAWING



MECHANICAL MODELING

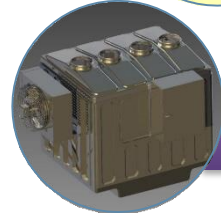

BIM CONSULTING



HVAC & PLUMBING MODELING

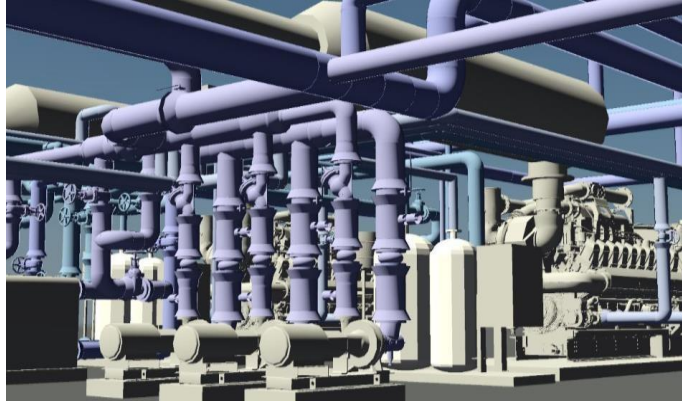

1. 3D MODELING

2. SHOP DRAWINGS

3. SPOOL DRAWING

4. AS BUILT DOCUMENTATION

5. QUANTITY TAKE OFF

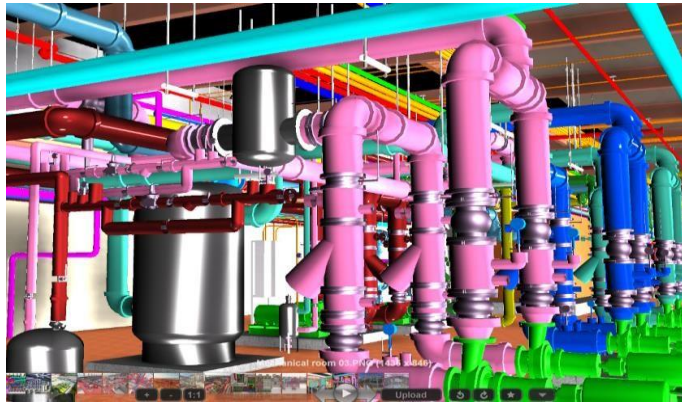
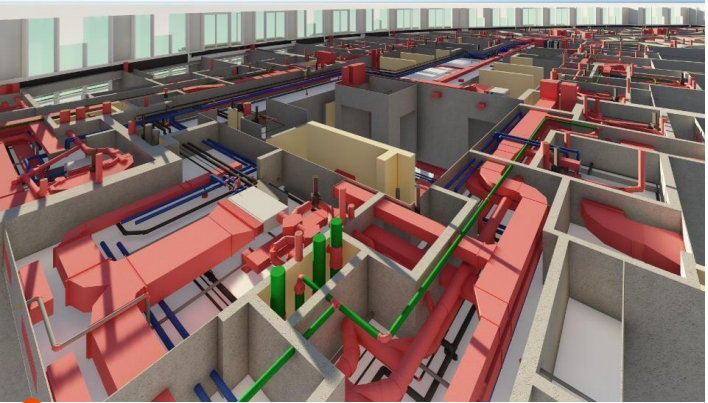

CLASH DETECTION & RESOLUTION

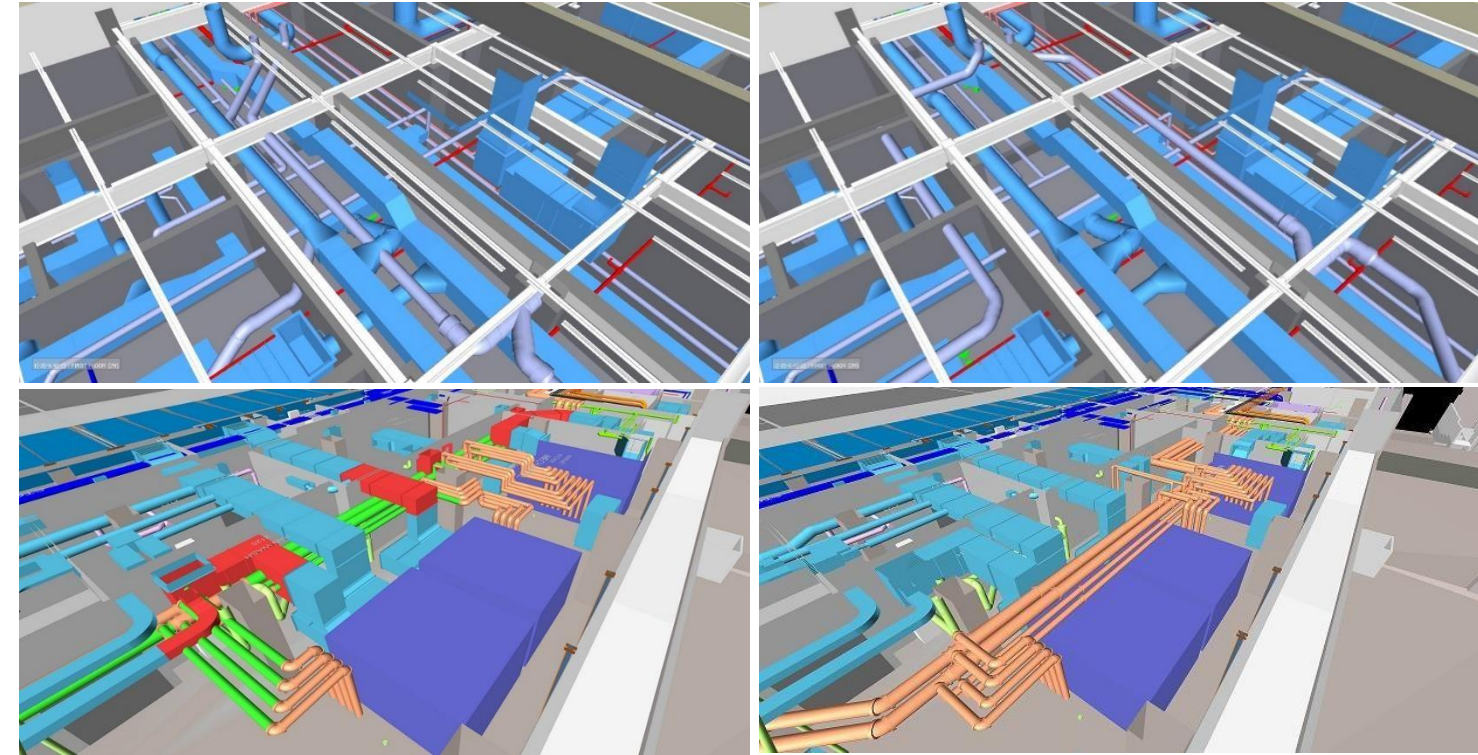

Before coordination

After coordination

Seamless coordination of MEP with Architecture & Structural trades, allowing all systems to work in perfect synchronization and at the same time maintaining the design intent.

Generation of Clash Reports, Resolution of Clashes and conducting BIM Coordination Meetings with contractors and other stakeholders.



POINTCLOUD MODELING

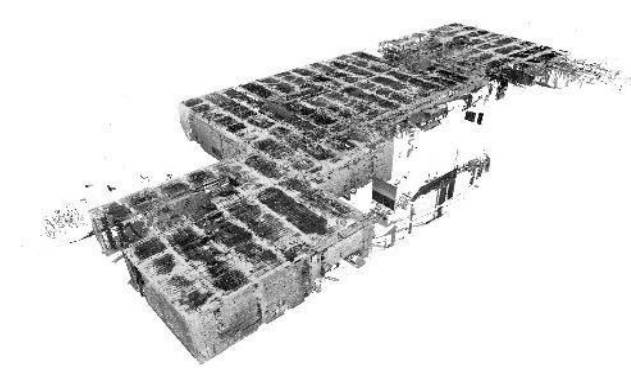
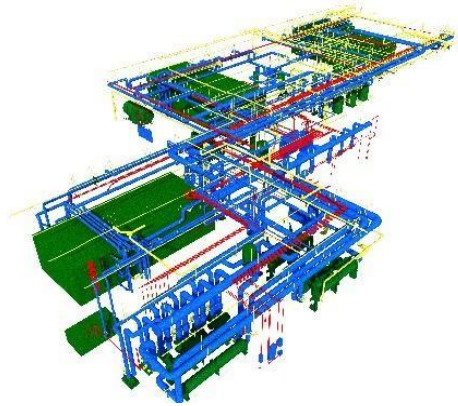

1. ARCHITECTURAL

2. STRUCTURAL

3. MEP



The 3D BIM model that we create from laser scan data serve as accurate models for as-built purposes as well as for Retrofit, Refurbishment and Renovation projects. It enables the creation of as-built BIM models for the renovation work of Infrastructure Assets such as tunnels and bridges.



REVIT FAMILY CREATION

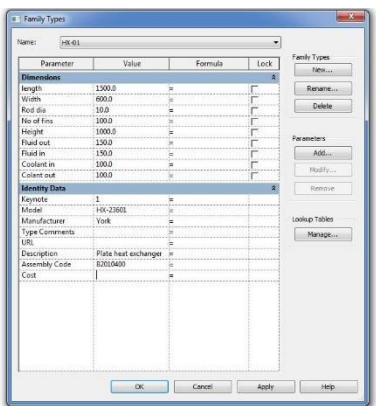
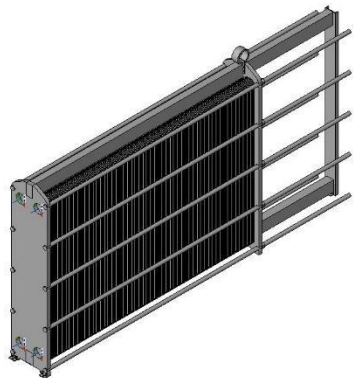

Creation of standard and customized Revit families for the retail, manufacturing and the construction industry from the manufacturer's submittals or even hand sketches.

1. Architectural elements

2. Structural components

3. Mechanical fittings

4. Plumbing fixtures

5. Product libraries

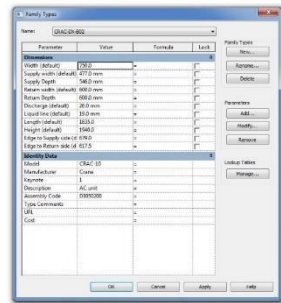
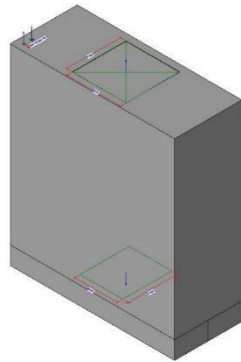
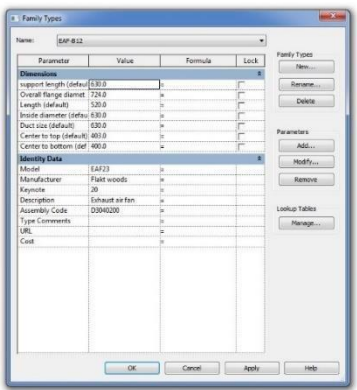
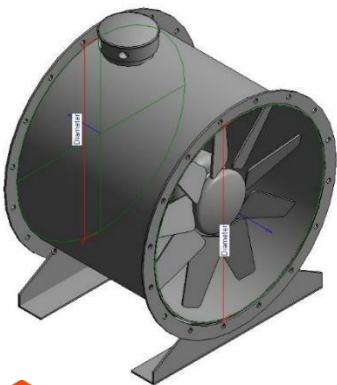

INDUSTRIAL MODELING

3D Cam
Elevation Front
Elevation Right
Elevation Top
3D DIMS PUMP SKID FRAMING
LIFTING LUG DETAIL
PUMP SKID FRAMING
SIDE VIEW

Line	Qty	Description	Std Part	Length (mm)	Qty
1	1	PUMP TANK 80 SCOT-10	80SCOT	460	1
2	1	PUMP TANK 80 SCOT-10	80SCOT	300	1
3	1	PUMP TANK 80 SCOT-10	80SCOT	460	1
4	1	PUMP TANK 80 SCOT-10	80SCOT	300	1
5	1	PUMP TANK 80 SCOT-10	80SCOT	300	1
6	1	PUMP TANK 80 SCOT-10	80SCOT	470	1
7	1	PUMP TANK 80 SCOT-10	80SCOT	300	1
8	1	PUMP TANK 80 SCOT-10	80SCOT	470	1
9	1	PUMP TANK 80 SCOT-10	80SCOT	300	1
10	1	PUMP TANK 80 SCOT-10	80SCOT	470	1
11	1	PUMP TANK 80 SCOT-10	80SCOT	190	2
12	1	PUMP TANK 80 SCOT-10	80SCOT	190	2
13	1	PUMP TANK 80 SCOT-10	80SCOT	190	2
14	1	PUMP TANK 80 SCOT-10	80SCOT	190	2
15	1	PUMP TANK 80 SCOT-10	80SCOT	190	2
16	1	PUMP TANK 80 SCOT-10	80SCOT	190	2
17	1	PUMP TANK 80 SCOT-10	80SCOT	190	2
18	1	PUMP TANK 80 SCOT-10	80SCOT	190	2
19	1	PUMP TANK 80 SCOT-10	80SCOT	190	2
20	1	PUMP TANK 80 SCOT-10	80SCOT	190	2
21	1	PUMP TANK 80 SCOT-10	80SCOT	190	2
22	1	PUMP TANK 80 SCOT-10	80SCOT	190	2
23	1	PUMP TANK 80 SCOT-10	80SCOT	190	2
24	1	PUMP TANK 80 SCOT-10	80SCOT	190	2
25	1	PUMP TANK 80 SCOT-10	80SCOT	190	2
26	1	PUMP TANK 80 SCOT-10	80SCOT	190	2
27	1	PUMP TANK 80 SCOT-10	80SCOT	190	2
28	1	PUMP TANK 80 SCOT-10	80SCOT	190	2
29	1	PUMP TANK 80 SCOT-10	80SCOT	190	2
30	1	PUMP TANK 80 SCOT-10	80SCOT	190	2
31	1	PUMP TANK 80 SCOT-10	80SCOT	190	2
32	1	PUMP TANK 80 SCOT-10	80SCOT	190	2
33	1	PUMP TANK 80 SCOT-10	80SCOT	190	2
34	1	PUMP TANK 80 SCOT-10	80SCOT	190	2
35	1	PUMP TANK 80 SCOT-10	80SCOT	190	2
36	1	PUMP TANK 80 SCOT-10	80SCOT	190	2
37	1	PUMP TANK 80 SCOT-10	80SCOT	190	2
38	1	PUMP TANK 80 SCOT-10	80SCOT	190	2
39	1	PUMP TANK 80 SCOT-10	80SCOT	190	2
40	1	PUMP TANK 80 SCOT-10	80SCOT	190	2
41	1	PUMP TANK 80 SCOT-10	80SCOT	190	2
42	1	PUMP TANK 80 SCOT-10	80SCOT	190	2
43	1	PUMP TANK 80 SCOT-10	80SCOT	190	2
44	1	PUMP TANK 80 SCOT-10	80SCOT	190	2
45	1	PUMP TANK 80 SCOT-10	80SCOT	190	2
46	1	PUMP TANK 80 SCOT-10	80SCOT	190	2
47	1	PUMP TANK 80 SCOT-10	80SCOT	190	2
48	1	PUMP TANK 80 SCOT-10	80SCOT	190	2
49	1	PUMP TANK 80 SCOT-10	80SCOT	190	2
50	1	PUMP TANK 80 SCOT-10	80SCOT	190	2
51	1	PUMP TANK 80 SCOT-10	80SCOT	190	2
52	1	PUMP TANK 80 SCOT-10	80SCOT	190	2
53	1	PUMP TANK 80 SCOT-10	80SCOT	190	2
54	1	PUMP TANK 80 SCOT-10	80SCOT	190	2
55	1	PUMP TANK 80 SCOT-10	80SCOT	190	2
56	1	PUMP TANK 80 SCOT-10	80SCOT	190	2
57	1	PUMP TANK 80 SCOT-10	80SCOT	190	2
58	1	PUMP TANK 80 SCOT-10	80SCOT	190	2
59	1	PUMP TANK 80 SCOT-10	80SCOT	190	2
60	1	PUMP TANK 80 SCOT-10	80SCOT	190	2
61	1	PUMP TANK 80 SCOT-10	80SCOT	190	2
62	1	PUMP TANK 80 SCOT-10	80SCOT	190	2
63	1	PUMP TANK 80 SCOT-10	80SCOT	190	2
64	1	PUMP TANK 80 SCOT-10	80SCOT	190	2
65	1	PUMP TANK 80 SCOT-10	80SCOT	190	2
66	1	PUMP TANK 80 SCOT-10	80SCOT	190	2
67	1	PUMP TANK 80 SCOT-10	80SCOT	190	2
68	1	PUMP TANK 80 SCOT-10	80SCOT	190	2
69	1	PUMP TANK 80 SCOT-10	80SCOT	190	2
70	1	PUMP TANK 80 SCOT-10	80SCOT	190	2
71	1	PUMP TANK 80 SCOT-10	80SCOT	190	2
72	1	PUMP TANK 80 SCOT-10	80SCOT	190	2
73	1	PUMP TANK 80 SCOT-10	80SCOT	190	2
74	1	PUMP TANK 80 SCOT-10	80SCOT	190	2
75	1	PUMP TANK 80 SCOT-10	80SCOT	190	2
76	1	PUMP TANK 80 SCOT-10	80SCOT	190	2
77	1	PUMP TANK 80 SCOT-10	80SCOT	190	2
78	1	PUMP TANK 80 SCOT-10	80SCOT	190	2
79	1	PUMP TANK 80 SCOT-10	80SCOT	190	2
80	1	PUMP TANK 80 SCOT-10	80SCOT	190	2
81	1	PUMP TANK 80 SCOT-10	80SCOT	190	2
82	1	PUMP TANK 80 SCOT-10	80SCOT	190	2
83	1	PUMP TANK 80 SCOT-10	80SCOT	190	2
84	1	PUMP TANK 80 SCOT-10	80SCOT	190	2
85	1	PUMP TANK 80 SCOT-10	80SCOT	190	2
86	1	PUMP TANK 80 SCOT-10	80SCOT	190	2
87	1	PUMP TANK 80 SCOT-10	80SCOT	190	2
88	1	PUMP TANK 80 SCOT-10	80SCOT	190	2
89	1	PUMP TANK 80 SCOT-10	80SCOT	190	2
90	1	PUMP TANK 80 SCOT-10	80SCOT	190	2
91	1	PUMP TANK 80 SCOT-10	80SCOT	190	2
92	1	PUMP TANK 80 SCOT-10	80SCOT	190	2
93	1	PUMP TANK 80 SCOT-10	80SCOT	190	2
94	1	PUMP TANK 80 SCOT-10	80SCOT	190	2
95	1	PUMP TANK 80 SCOT-10	80SCOT	190	2
96	1	PUMP TANK 80 SCOT-10	80SCOT	190	2
97	1	PUMP TANK 80 SCOT-10	80SCOT	190	2
98	1	PUMP TANK 80 SCOT-10	80SCOT	190	2
99	1	PUMP TANK 80 SCOT-10	80SCOT	190	2
100	1	PUMP TANK 80 SCOT-10	80SCOT	190	2

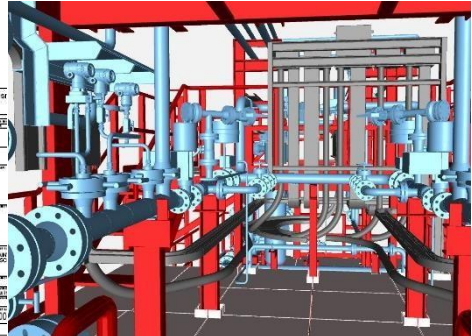
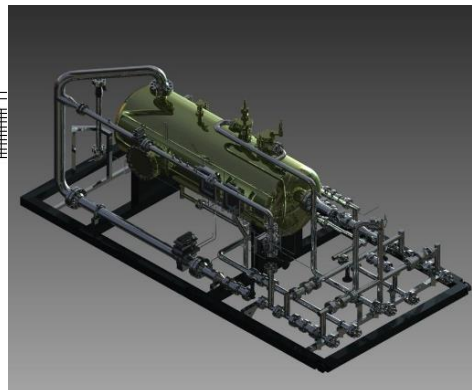

1. P & I diagram

2. BIM object creation

3. GA & Equipment Layout

4. Structural Frame arrangement

5. Process Schematic Diagram

6. Process Piping drawings



BIM CONSULTING

Since 2007 we have been assisting construction companies, general & specialty contractors in their migration to BIM from CAD. We act as a strategic BIM partner to the client educating and training them for seamless migration from CAD drafting to BIM implementation.

- 1. BIM Model Audit
- 2. Offshore BIM Team
- 3. BIM Implementation Planning
- 4. BIM Training
- 5. On-Site BIM Support

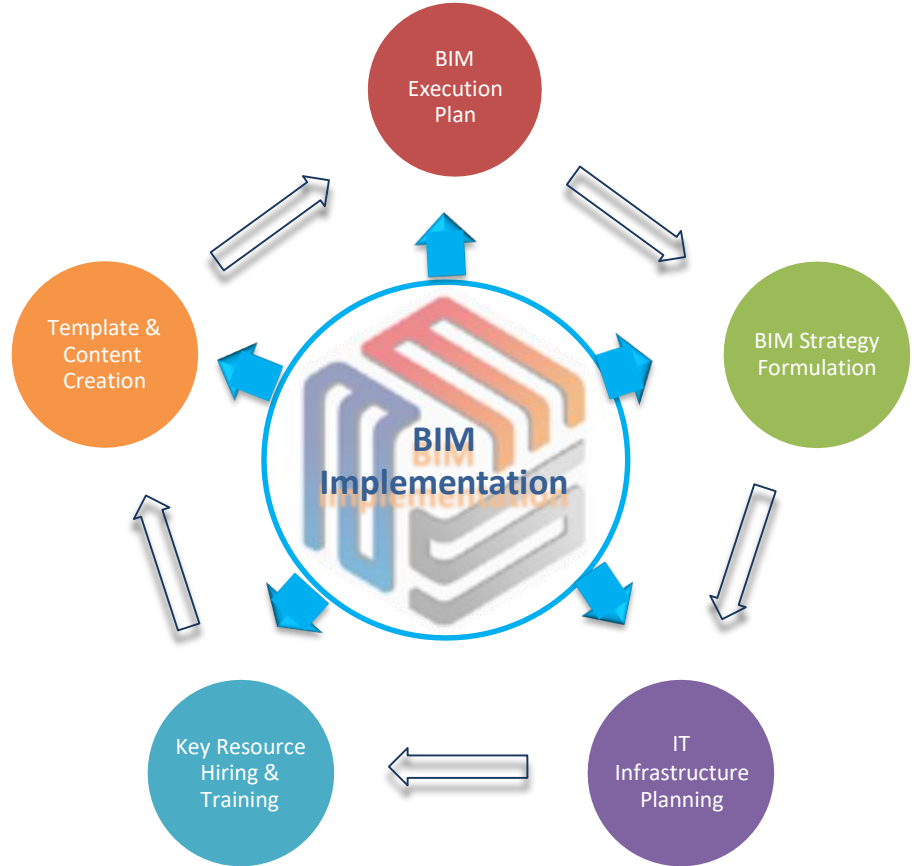

MECHANICAL MODELING



Desiccant Dryer

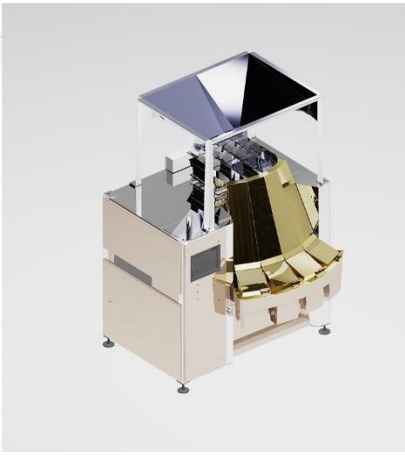
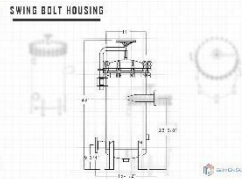
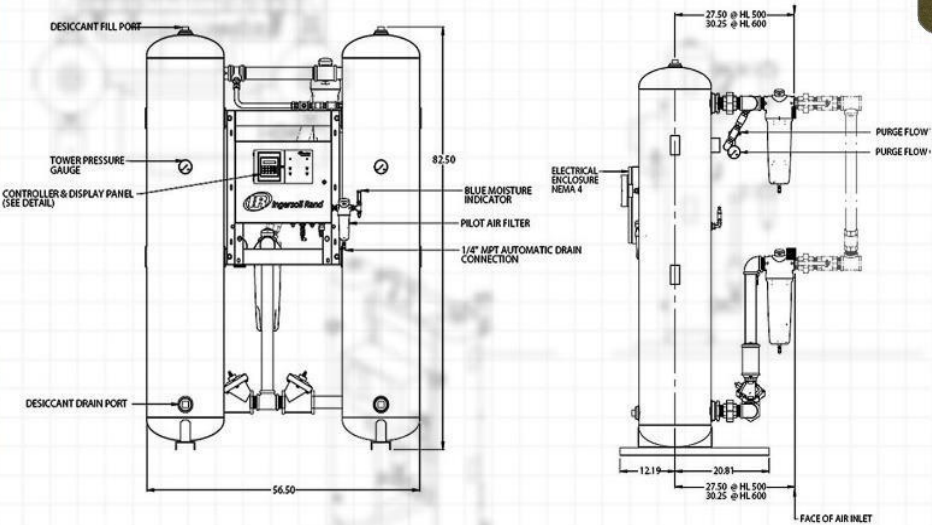

OUR DETAILING PROCEDURE

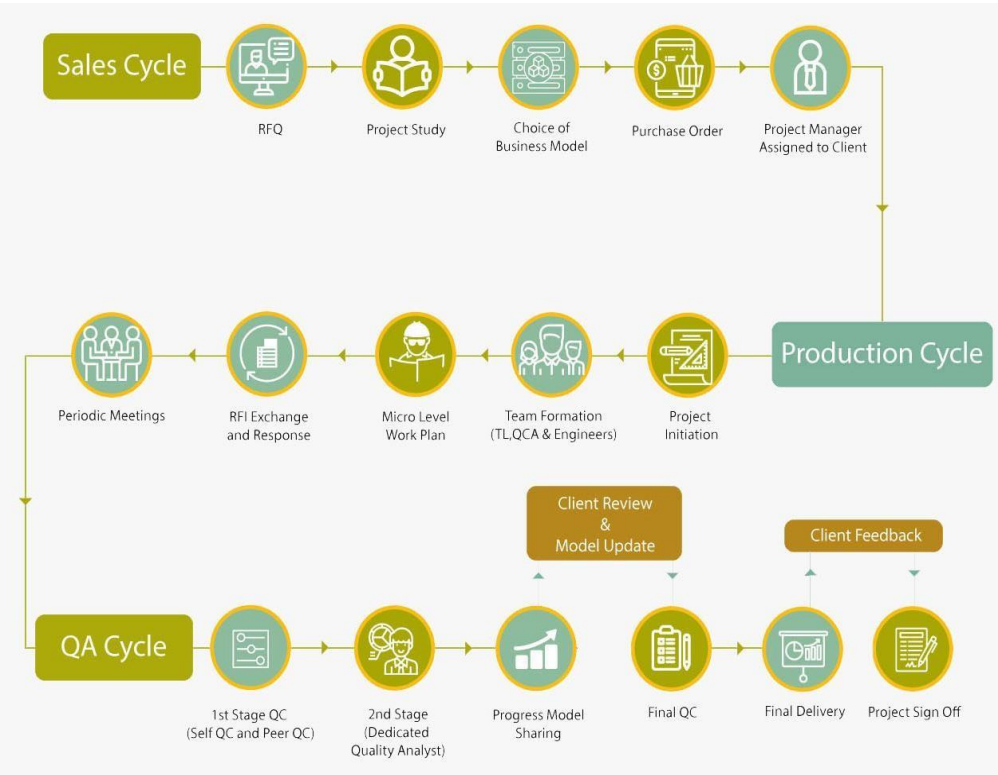

OUR APPROACH

Understanding Client Requirements : With every client, we understand that a different approach may need to be employed with every project, bringing a new set of skills and technology to the table. We devote the time needed to study the objective of the project.

Delivering Solutions : To achieve the goals of the project, our engineers adopt the most appropriate methods, outdoing themselves. Our work is to follow a system driven process incorporating the latest methods in the BIM industry which ensures projects are delivered on time and are nothing short of the highest quality..

Constant Improvement: The engineering team, led by highly capable and seasoned project managers tirelessly learn, research and update themselves to meet the ever-changing and dynamic demands of the AEC industry. Systematic knowledge sharing and perfection of the work process is an ongoing process in Advenser. With every project, we see to it that we always make room for innovation.

Our Promise : Client satisfaction is a promise we assure and we measure our successes on par with that of our client's. We take pride in our past glory & achievements but at the same time strive to make them nothing more than mere milestones in our pursuit of excellence.



TEAM PROFICIENCY & SOFTWARE PROFICIENCY

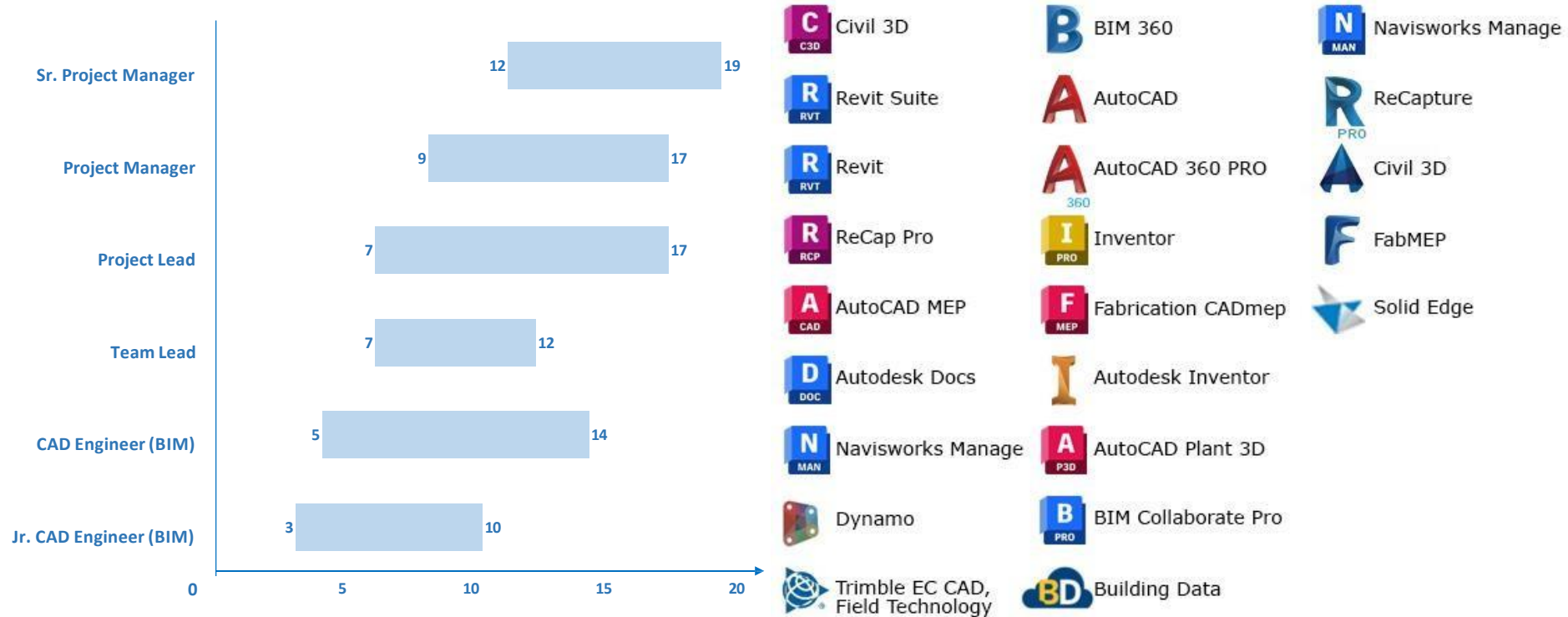

FEATURED PROJECTS

Imperial Avenue, UAE



FEATURED PROJECTS

Biogen Oligo Labs building, MA, USA

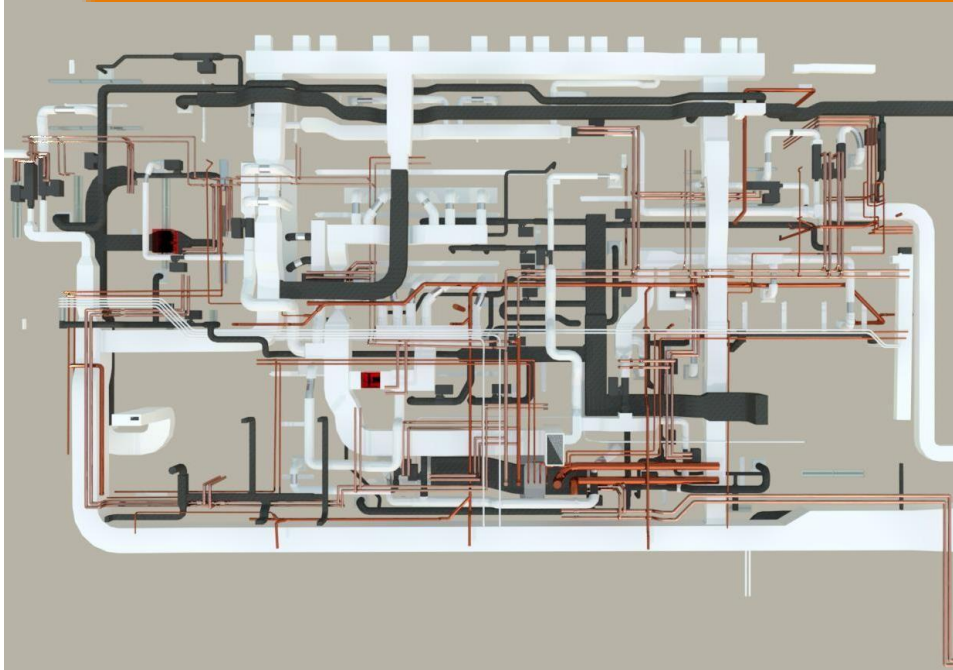

FEATURED PROJECTS

Westfield University, MA , USA



FEATURED PROJECTS

CCU building- Annexure, SC, USA

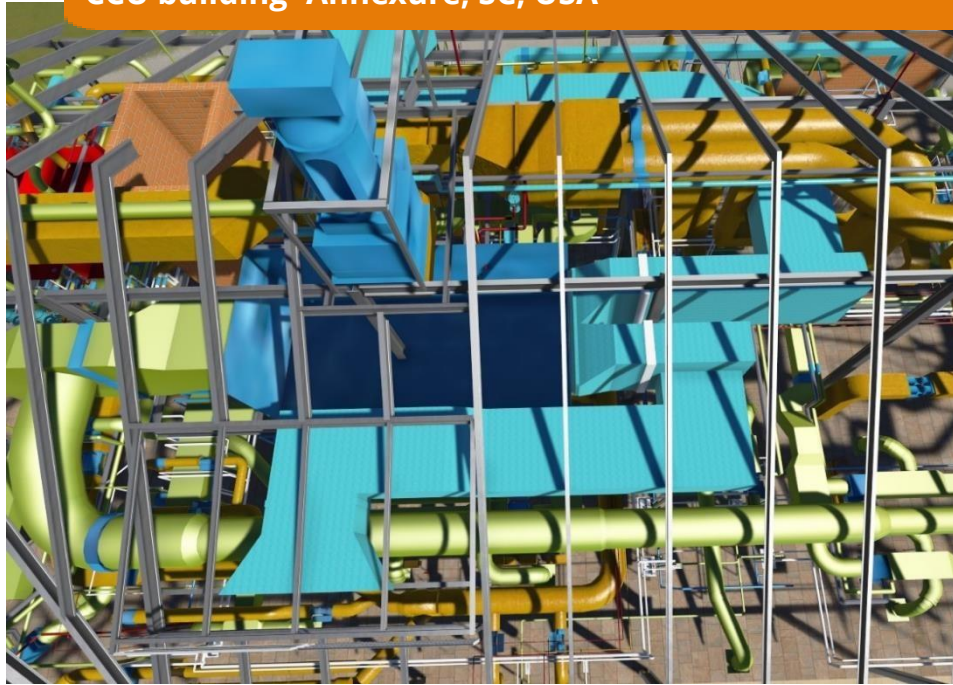

FEATURED PROJECTS

Fort Bliss Clinics, TX, USA

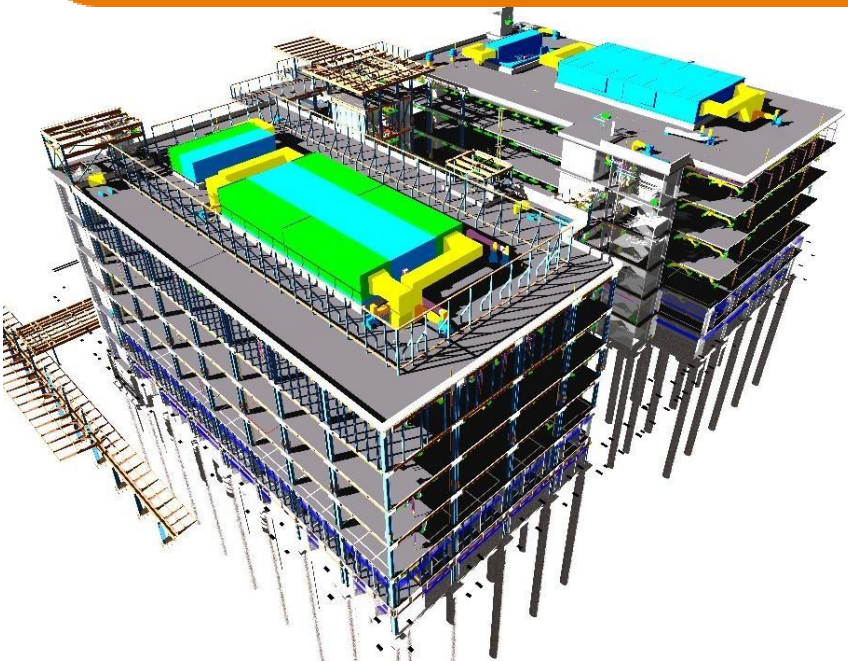

FEATURED PROJECTS

UMASS Chapel, MA, USA



FEATURED PROJECTS

West Haven Combined Heat & Power CHP, VA, USA

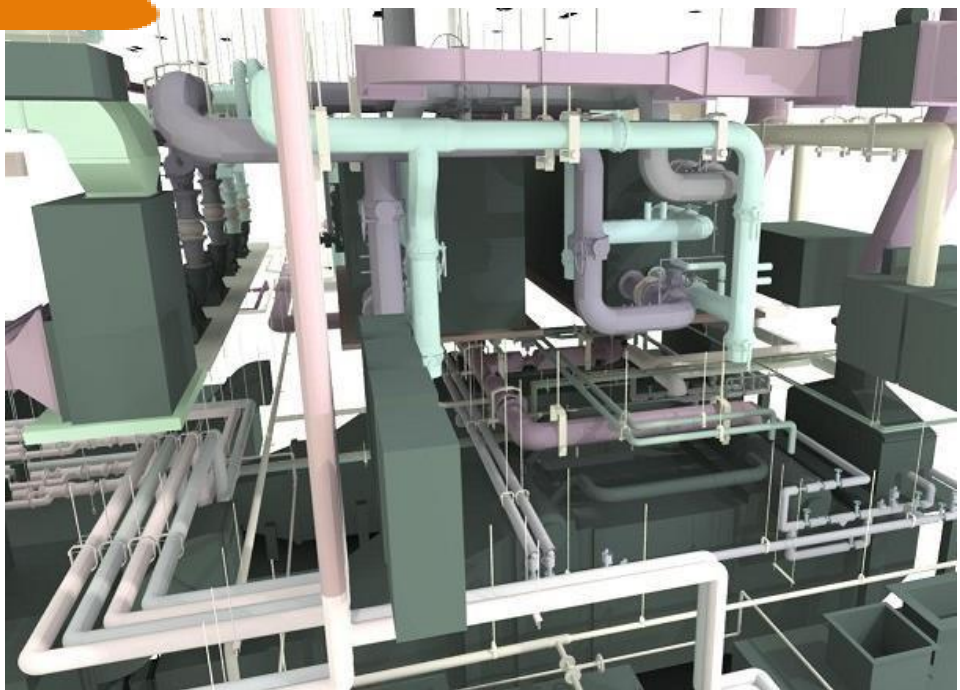

FEATURED PROJECTS

Mystic Seaport, CT, USA



FEATURED PROJECTS

Honda-Toyota Showroom, WA, USA

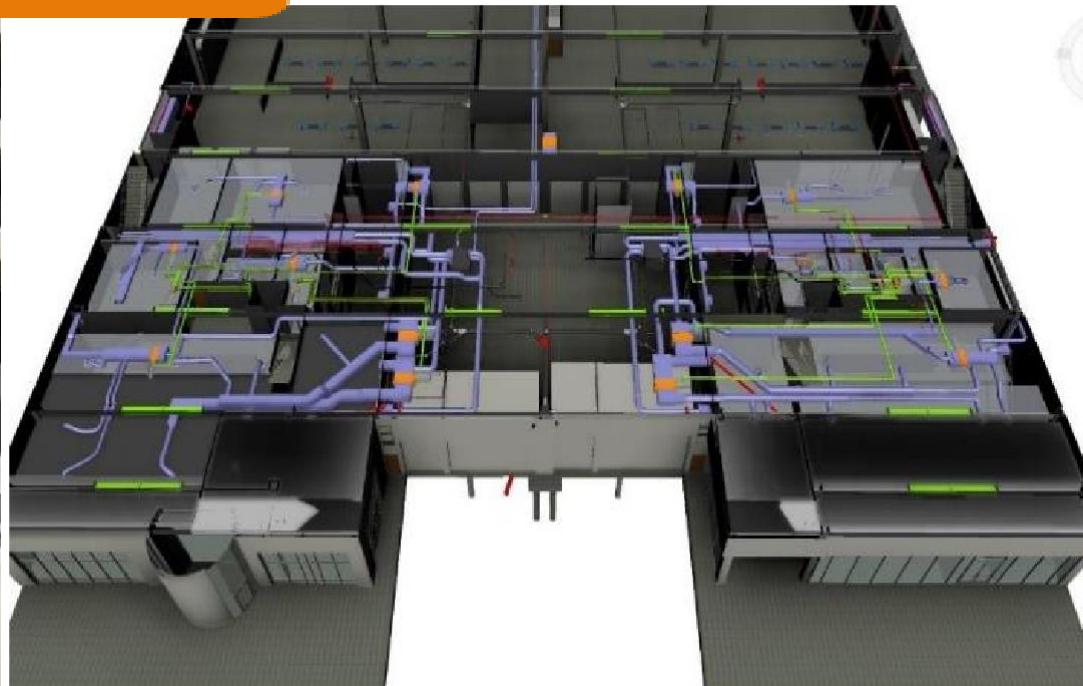

FEATURED PROJECTS

7001 Arlington, MD, USA



FEATURED PROJECTS

Shriners Hospital, OH, USA

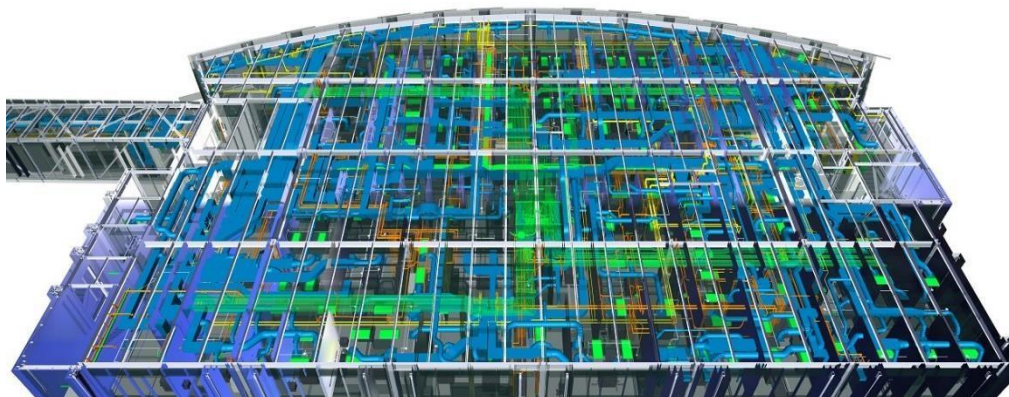

FEATURED PROJECTS

Peiŕh Police Station, WA, Ausŕialia



CONTACT US



Advenser Technology Services, Inc.

Five Neshaminy Interplex, STE 205
Trevose, PA 19053, USA
Phone: +1 (215) 791 7955



Advenser LLC

Five Neshaminy Interplex, STE 205
Trevose, PA 19053, USA
Phone: +1 (215) 934 2868



Advenser Engineering Services Pvt. Ltd.

43 A, E block, 4F CSEZ, Kakkanad
Kochi, Kerala, India. Pin 682 037
Phone: +91 484 298 8448



Advenser Engineering Systems LLC

P.O. Box No: 118901,
Dubai, UAE
Phone: +971 50 237 7430



Advenser Engineering Services Pty. Ltd.

Unit 26, 14 Jubilee Avenue
Warriewood NSW 2102, Australia
Phone: +61 363 877 090



Advenser Engineering Services Pvt. Ltd.

403, 4F, Lulu Cyber Tower 1, Infopark
Kochi, Kerala, India. Pin 682 042
Phone: +91 484 404 0708



www.advenser.com



info@advenser.com

www.advenser.com

THANK YOU



info@advenser.com